

F 015 239 501

Stand } 11-01-14 **Fig./Abb. 1**

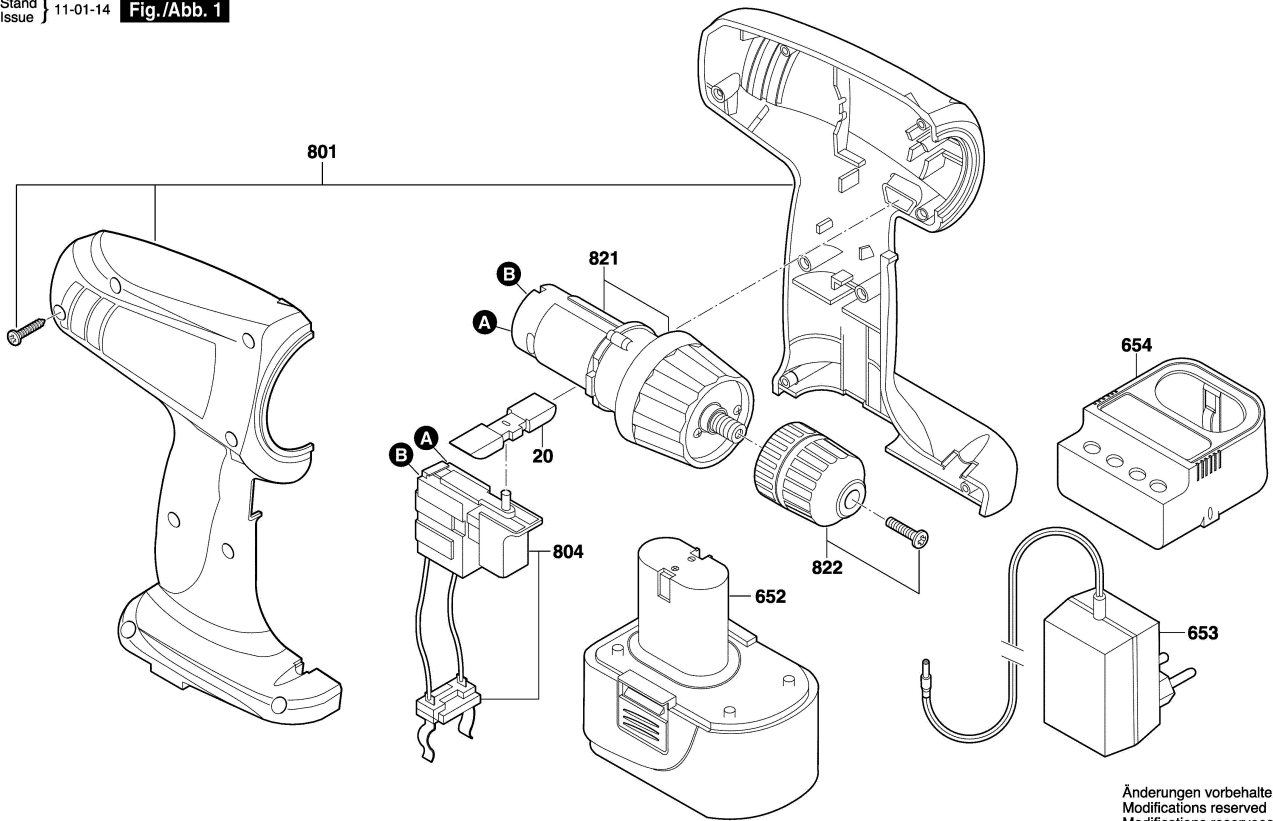

Änderungen vorbehalten
Modifications reserved
Modificaciones reservadas
Salvo modificaciones