

WARNING! Electrical repairs should be attempted only by trained repairmen. Contact the nearest SKIL Service Center or other competent repair service.

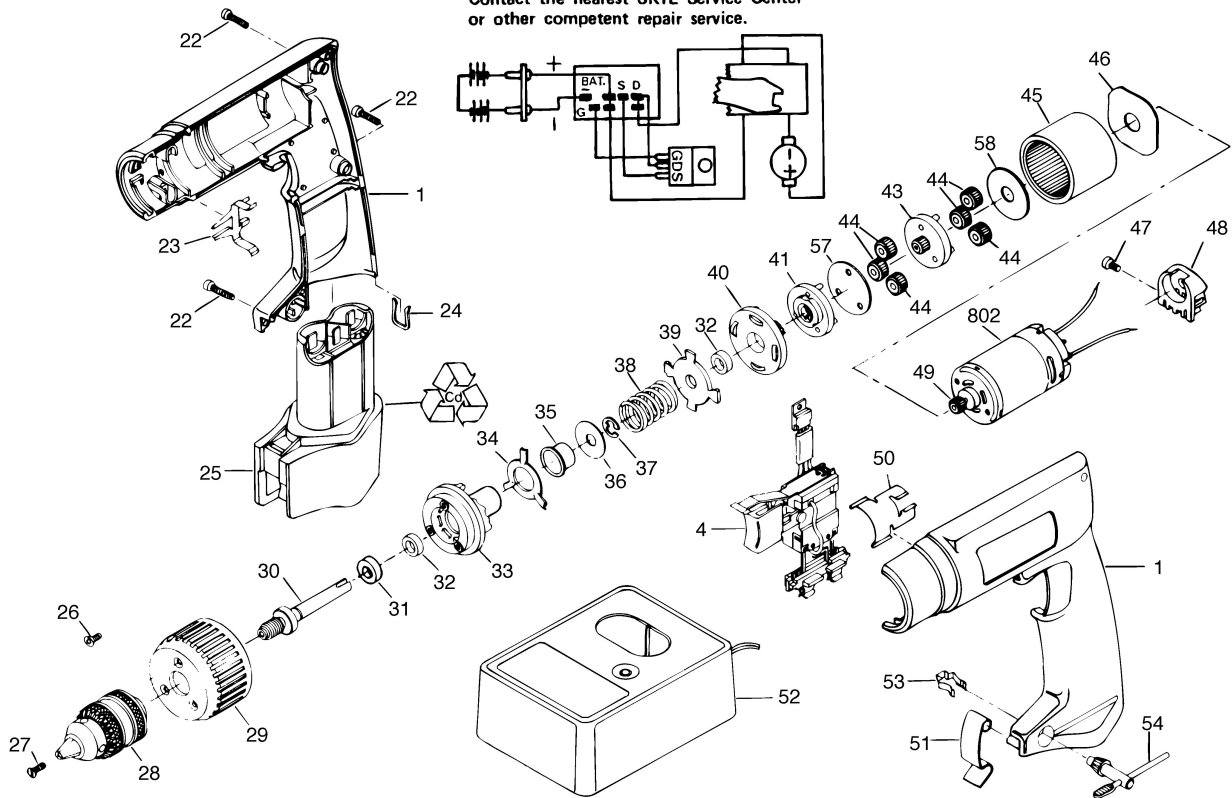

F0152537A11

Änderungen vorbehalten
 Modifications reserved
 Modifications reserves
 Salvo modificaciones