

F015 295 5A1

Stand 10-05-03
Issue 00-05-30

Fig./Abb. 1

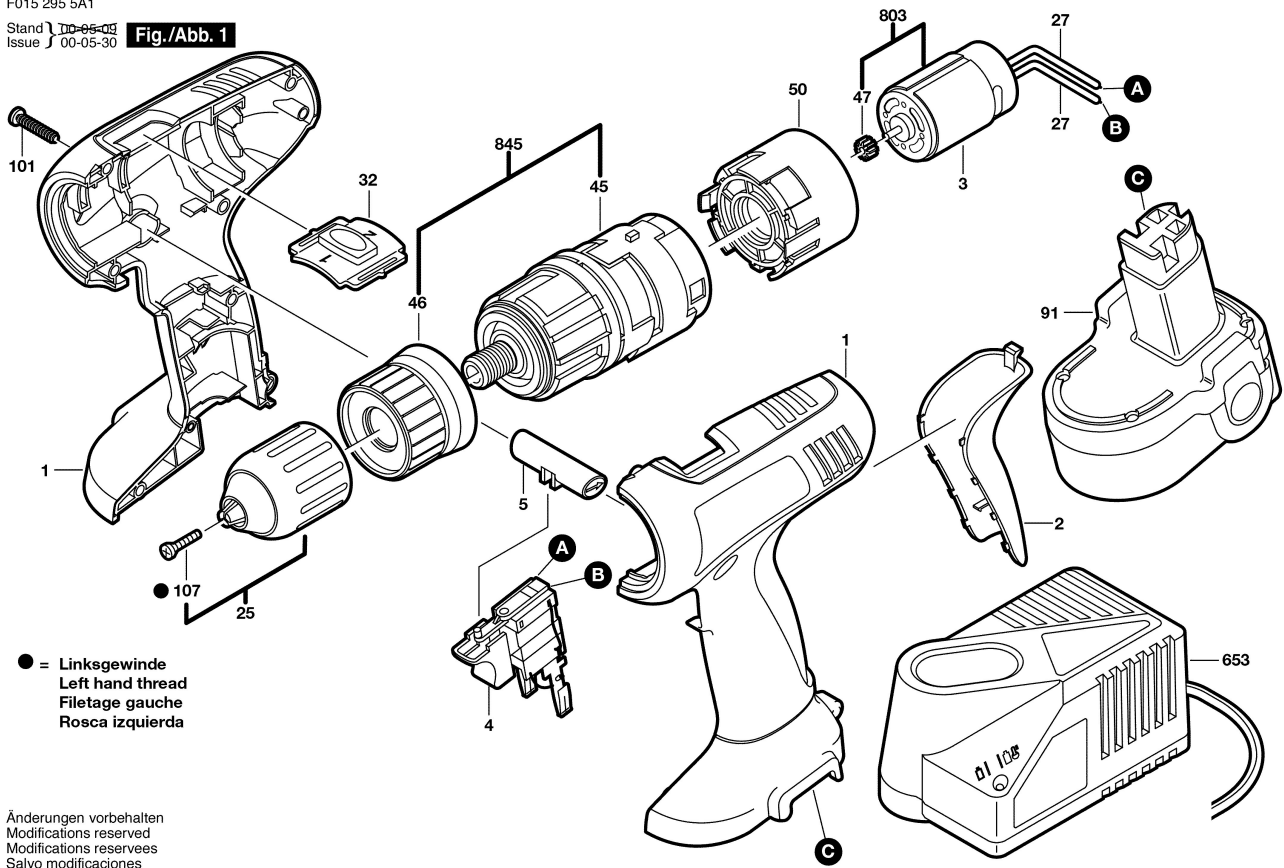

● = Linksgewinde
Left hand thread
Filetage gauche
Rosca izquiera

Änderungen vorbehalten
Modifications reserved
Modifications reserves
Salvo modificaciones