

F 015 417 011
Stand 06-11-23
Issue 06-11-24

Fig./Abb. 1

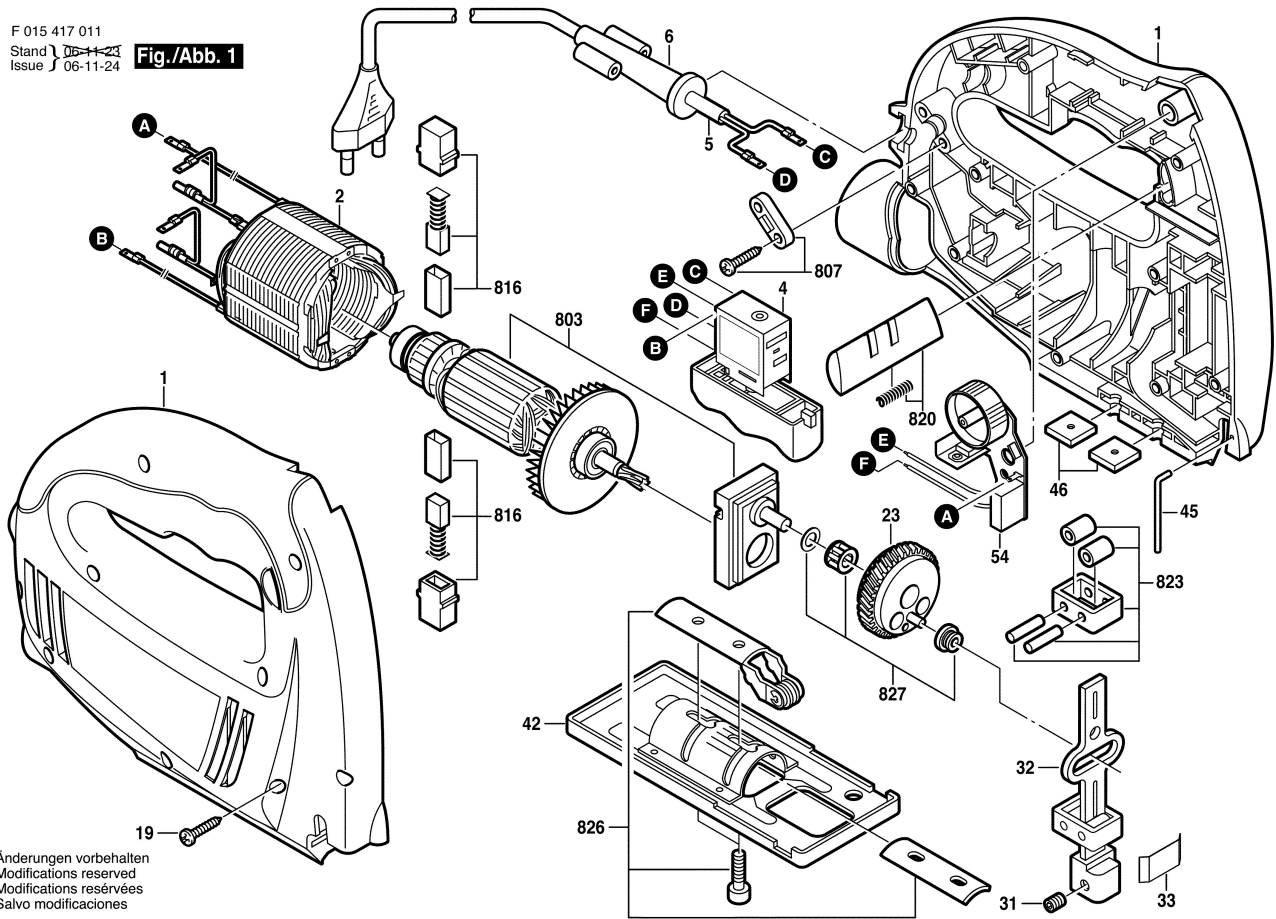

Änderungen vorbehalten
Modifications reserved
Modifications réservées
Salvo modificaciones