

F 015 500 301
Stand 10-84
Issue 09-09-09

Fig./Abb. 1

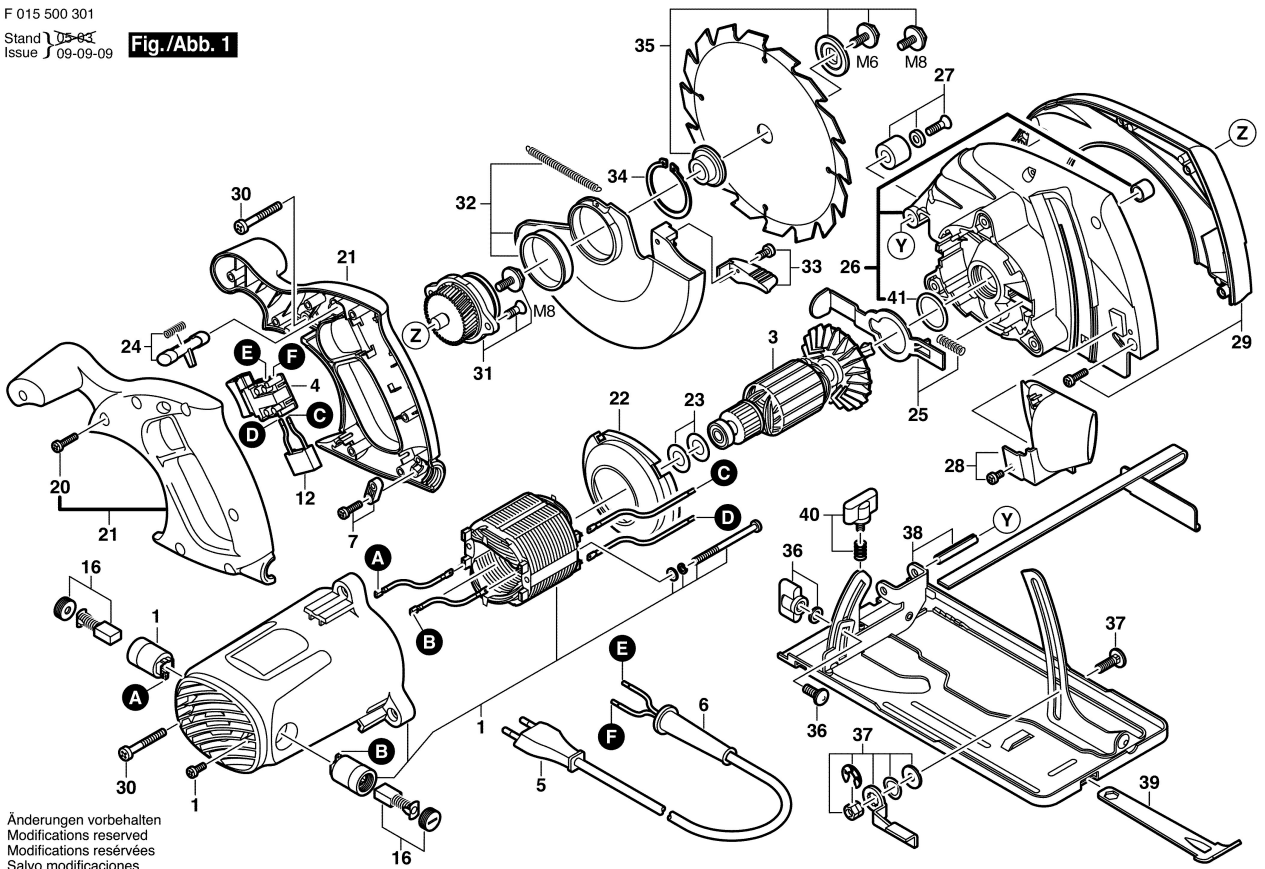

Änderungen vorbehalten
Modifications reserved
Modifications réservées
Salvo modificaciones