

F 015 530 124

Stand | 13-09-11
Issue | 13-12-18

Fig./Abb. 1

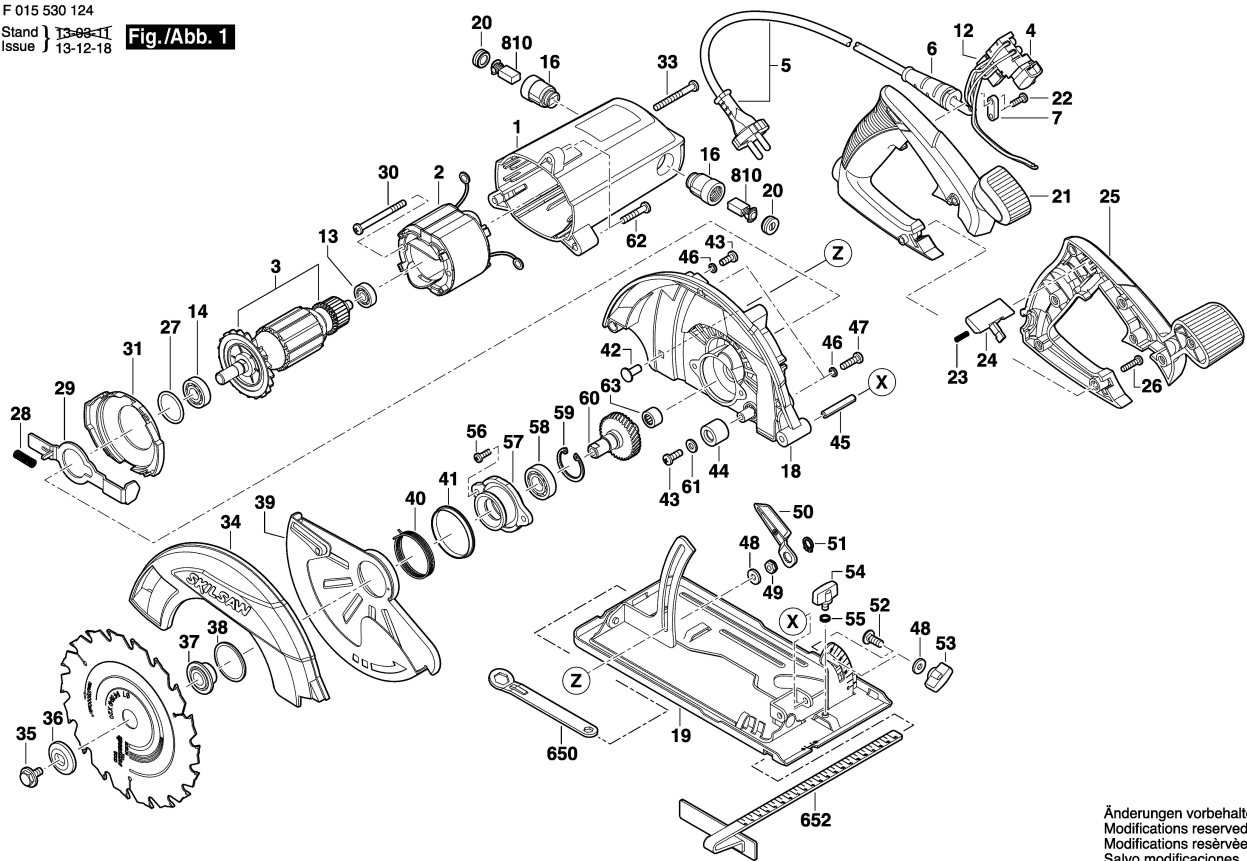

Änderungen vorbehalten
Modifications reserved
Modifications réservées
Salvo modificaciones