

F 015 525 501

Stand 13-06-28
Issue

Fig./Abb. 1

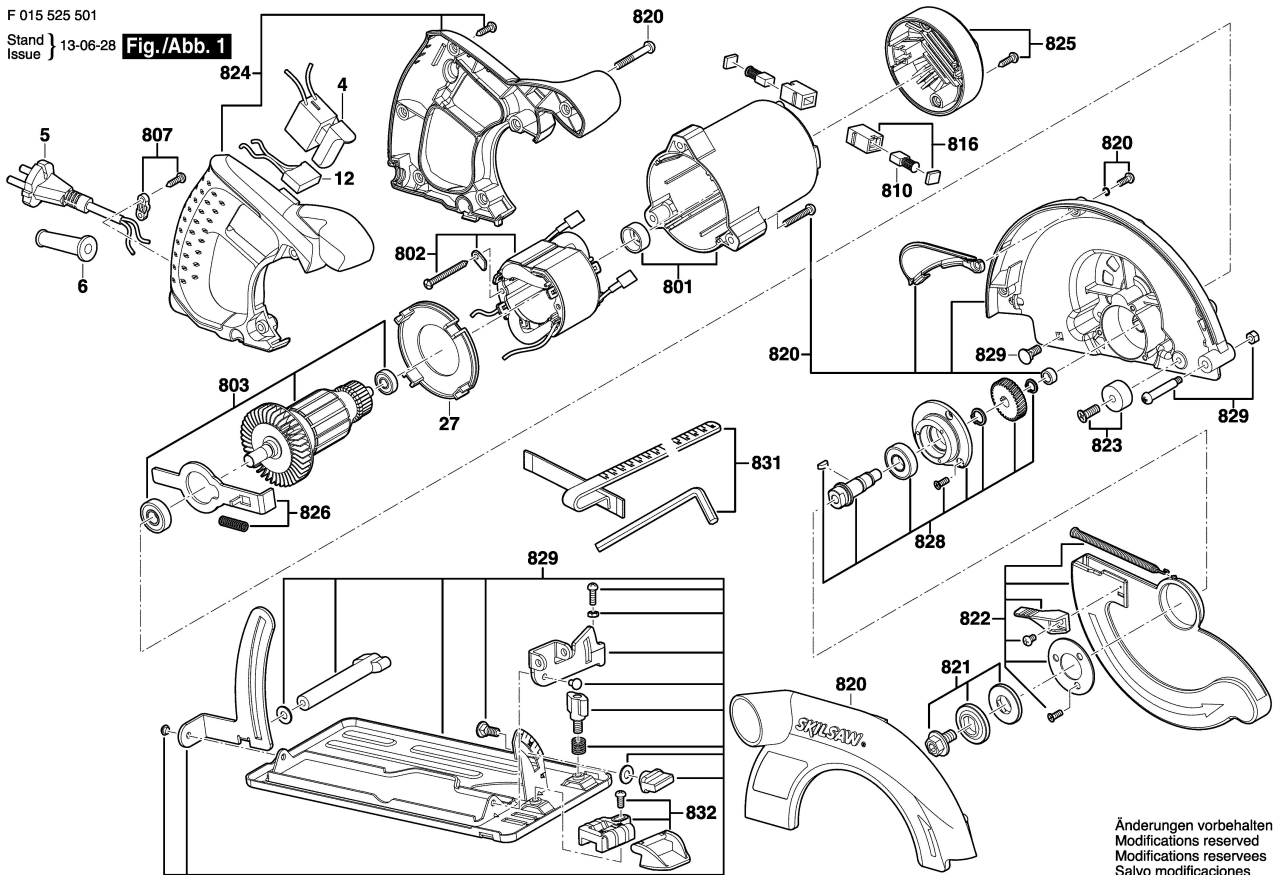

Änderungen vorbehalten
Modifications reserved
Modifications reserves
Salvo modificaciones