

F 015 585 511
Stand 07-10
Issue 08-01-14

Fig./Abb. 1

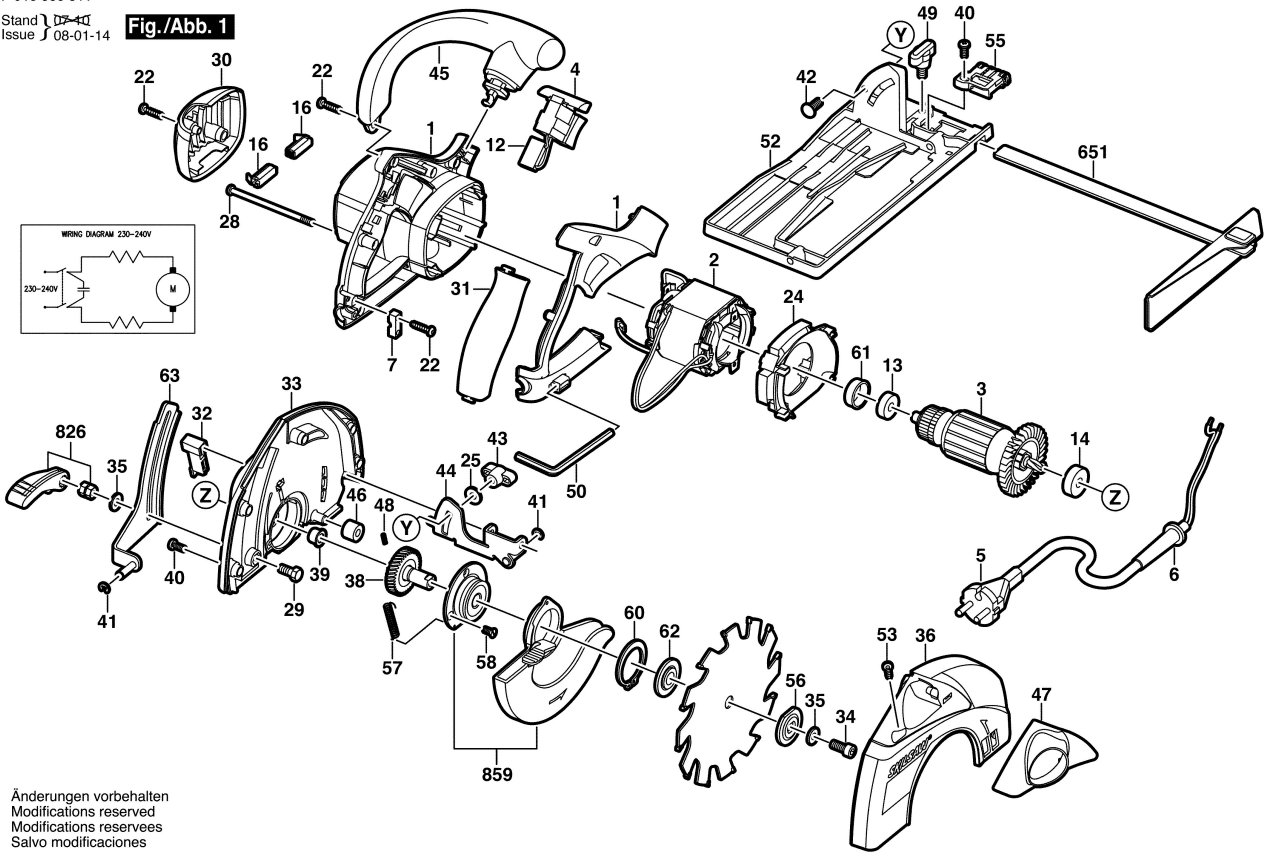

Änderungen vorbehalten
Modifications reserved
Modifications reserves
Salvo modificaciones