

F 015 584 001
Stand
Issue

08-01-24 **Fig./Abb. 1**

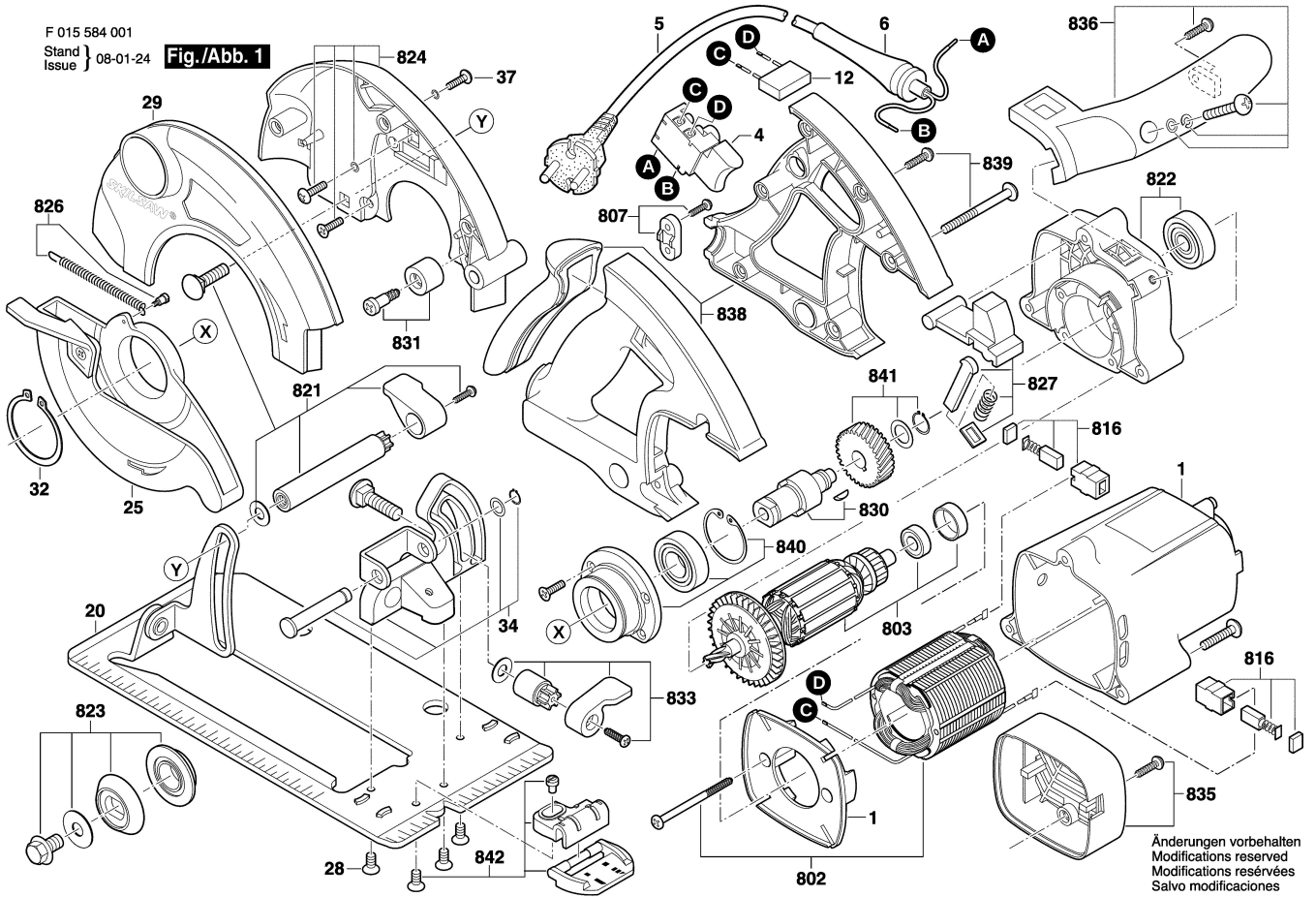

Änderungen vorbehalten
Modifications reserved
Modificaciones reservadas
Salvo modificaciones