

F 015 600 204
Stand } 11-11-28
Issue }

Fig./Abb. 1

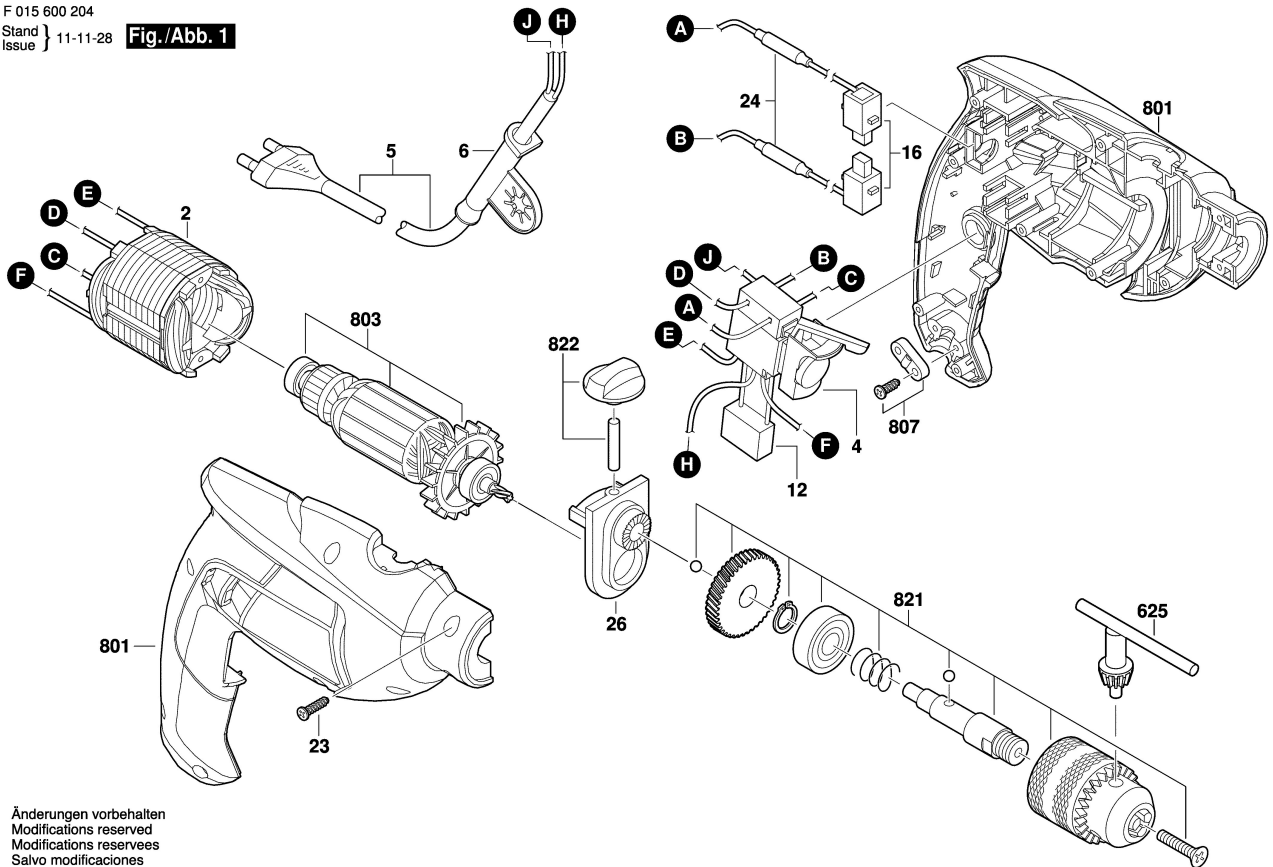

Änderungen vorbehalten
Modifications reserved
Modificaciones reservées
Salvo modificaciones