

F 015 628 001
Stand 05-11
Issue 06-06-14

Fig./Abb. 1

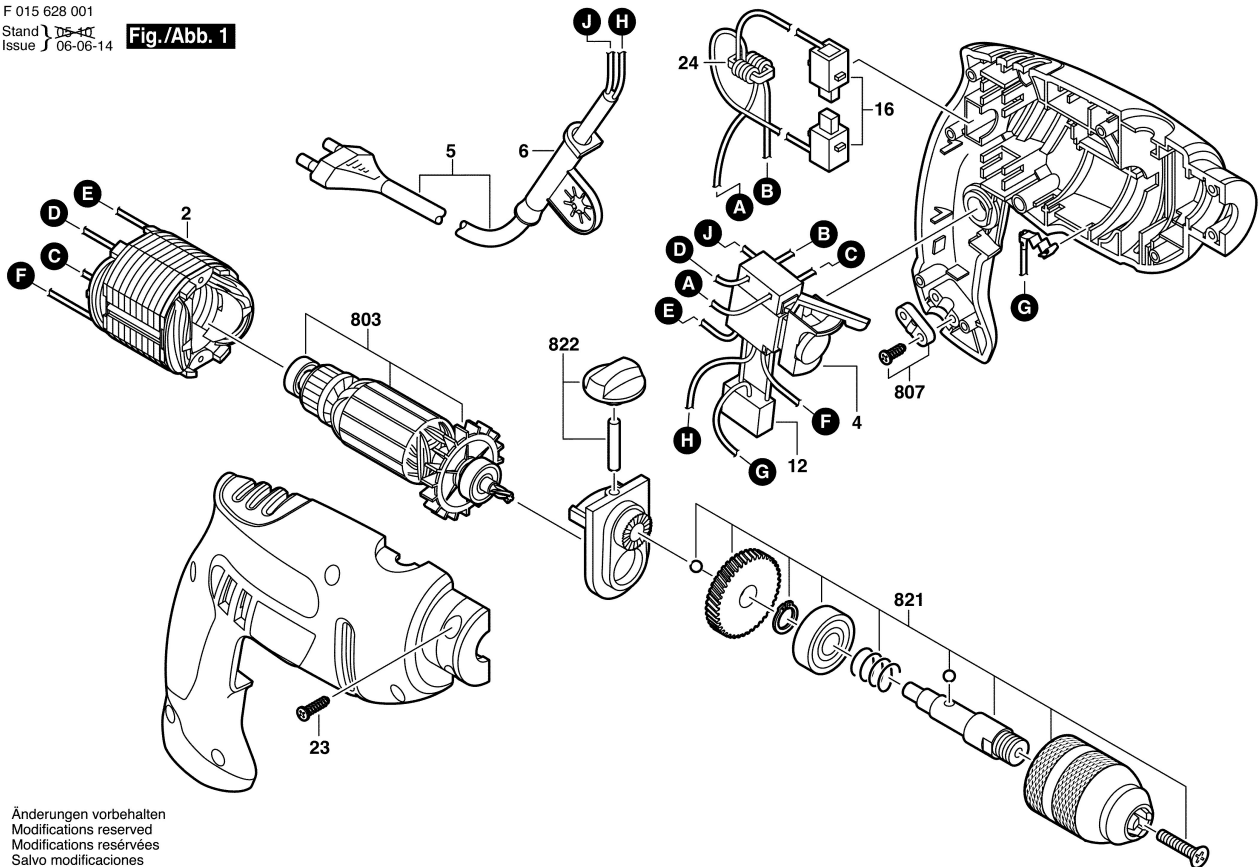

Änderungen vorbehalten
Modifications reserved
Modifications réservées
Salvo modificaciones