

F 015 609 201
Stand 05-12
Issue J 06-06-14

Fig./Abb. 1

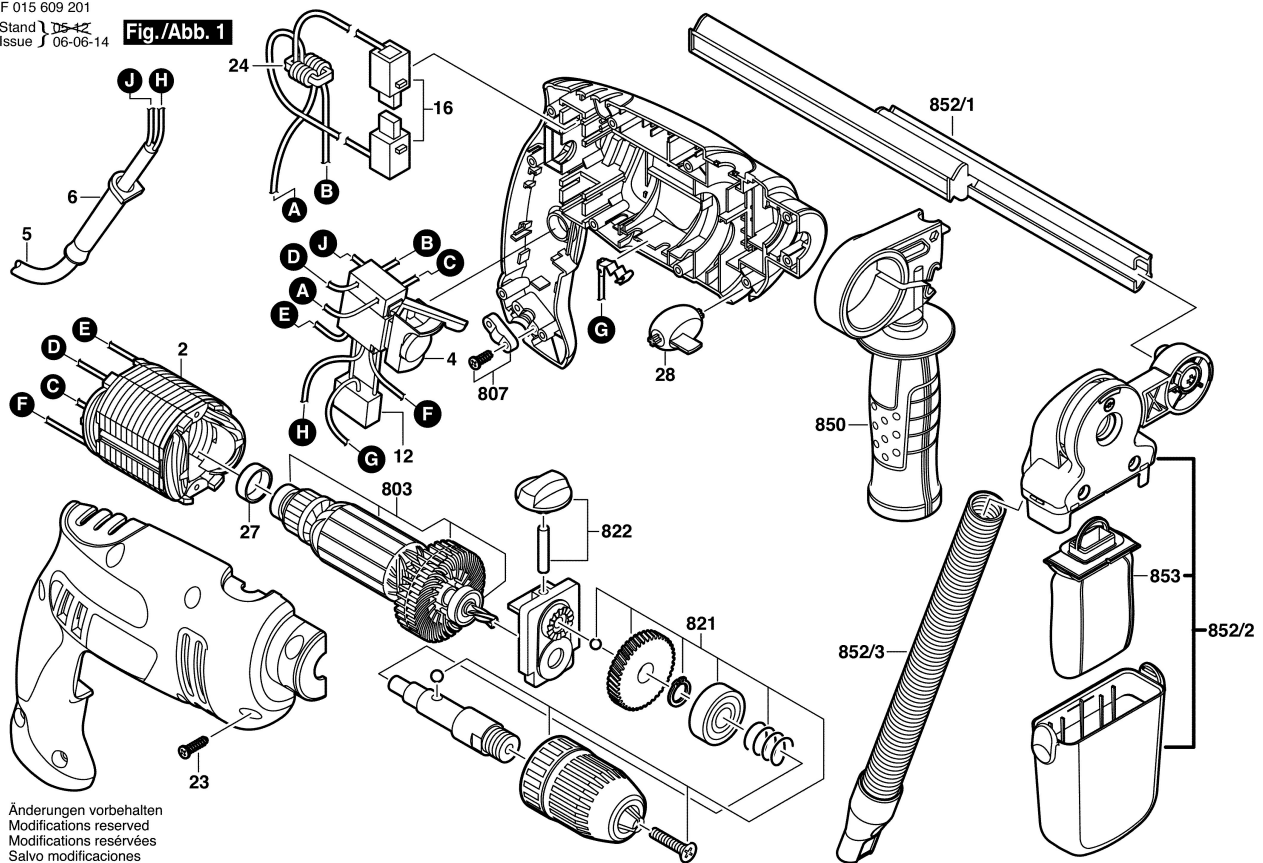

Änderungen vorbehalten
Modifications reserved
Modifications réservées
Salvo modificaciones