

F 015 622 001

Stand } 12-01-18
Issue }

Fig./Abb. 1

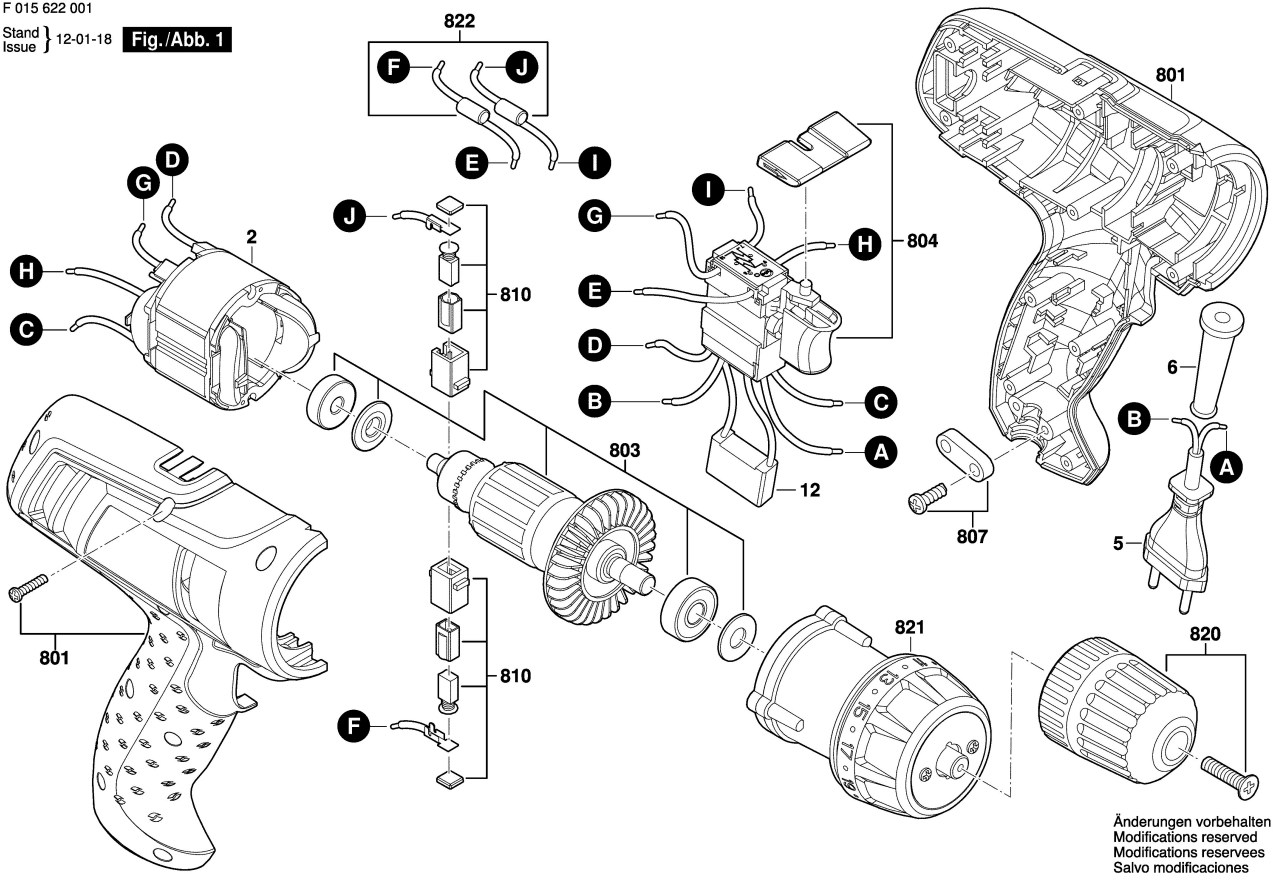

Änderungen vorbehalten
Modifications reserved
Modificaciones reservadas
Salvo modificaciones