

F 015 622 401

Stand | 14-01-15
Issue | 14-01-30

Fig./Abb. 1

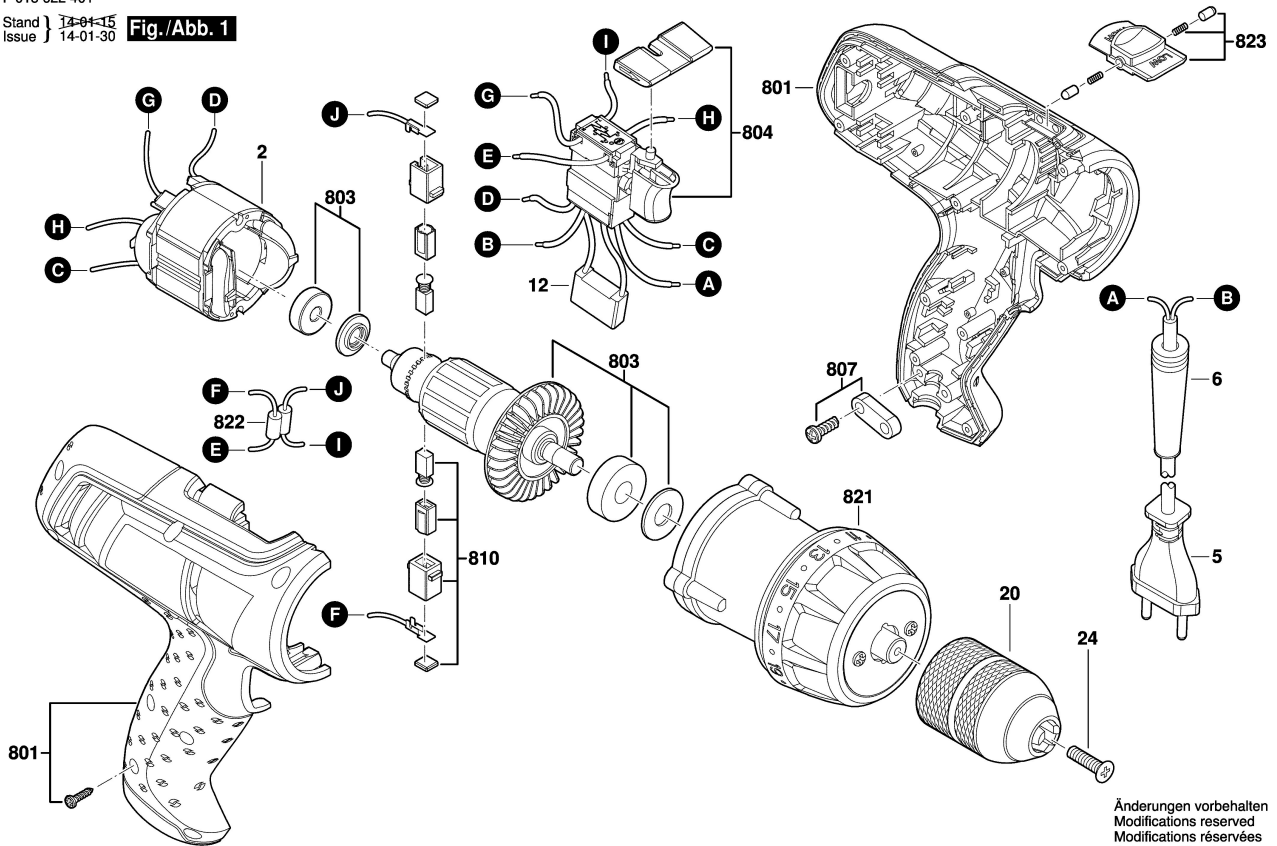

Änderungen vorbehalten
Modifications reserved
Modifications réservées
Salvo modificaciones