

F 015 628 001  
Stand 05-11  
Issue 06-06-14

**Fig./Abb. 1**

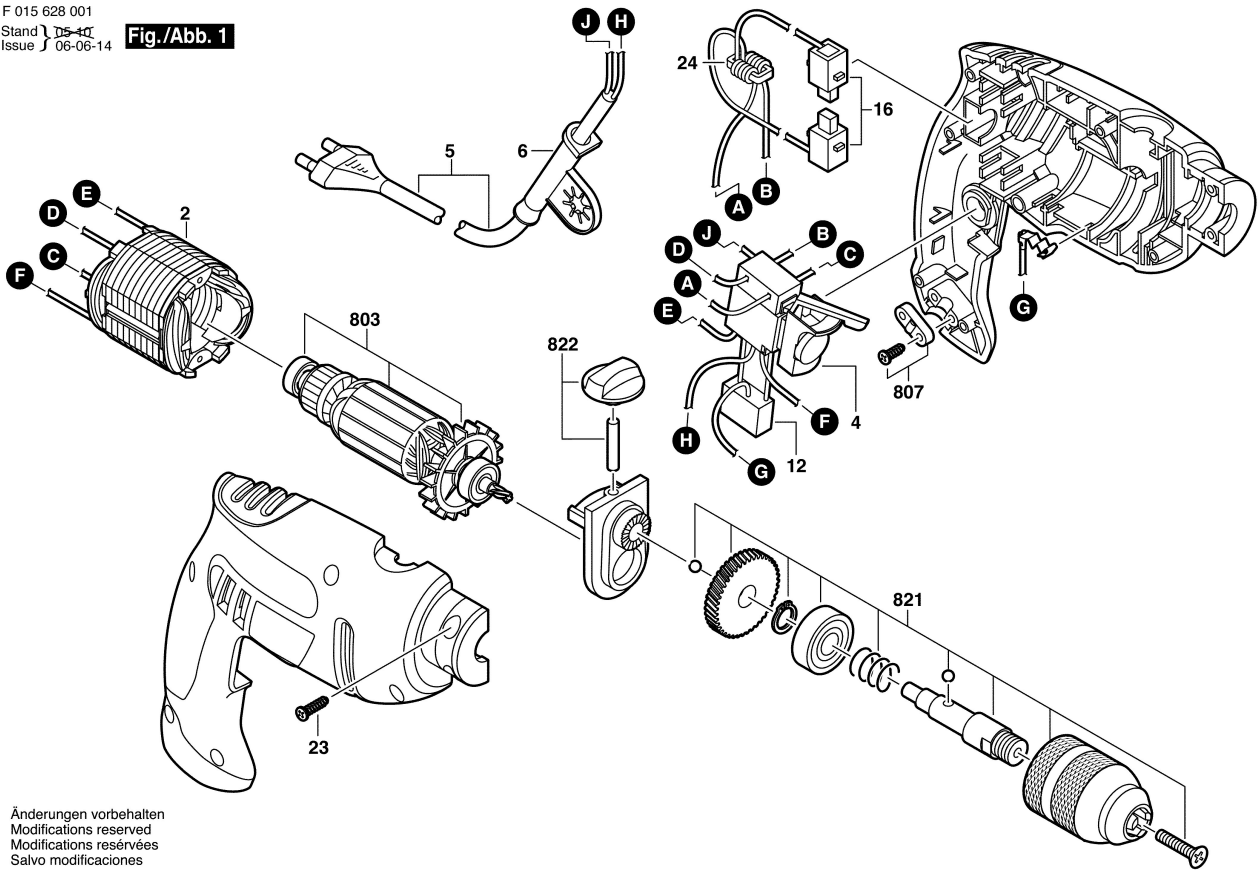

Änderungen vorbehalten  
Modifications reserved  
Modifications réservées  
Salvo modificaciones