

F 015 629 001

Stand } 11-12-07 **Fig./Abb. 1**

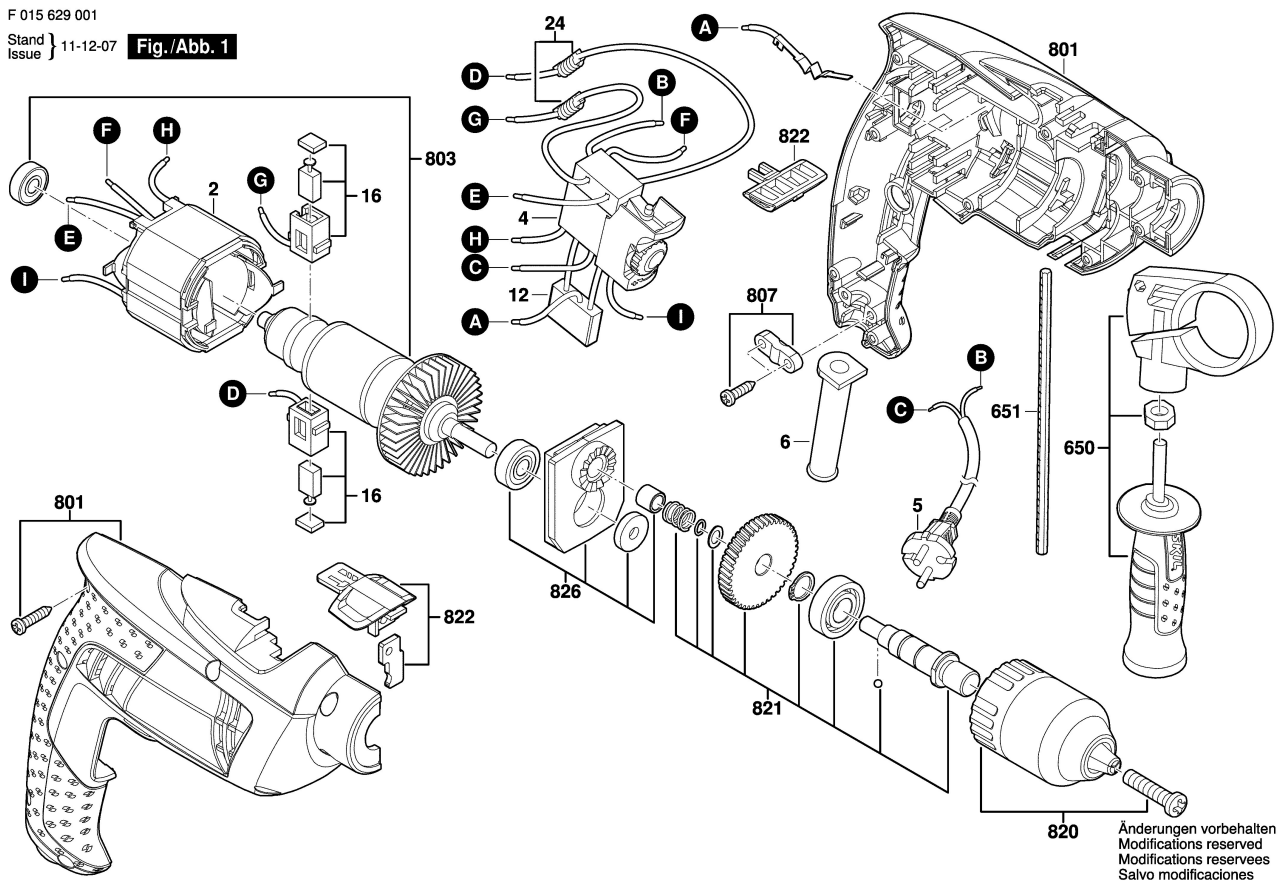

Änderungen vorbehalten
Modifications reserved
Modificaciones reservadas
Salvo modificaciones