

F 015 636 001

Stand } 03-08-05 **Abb./Fig. 1**  
Issue }

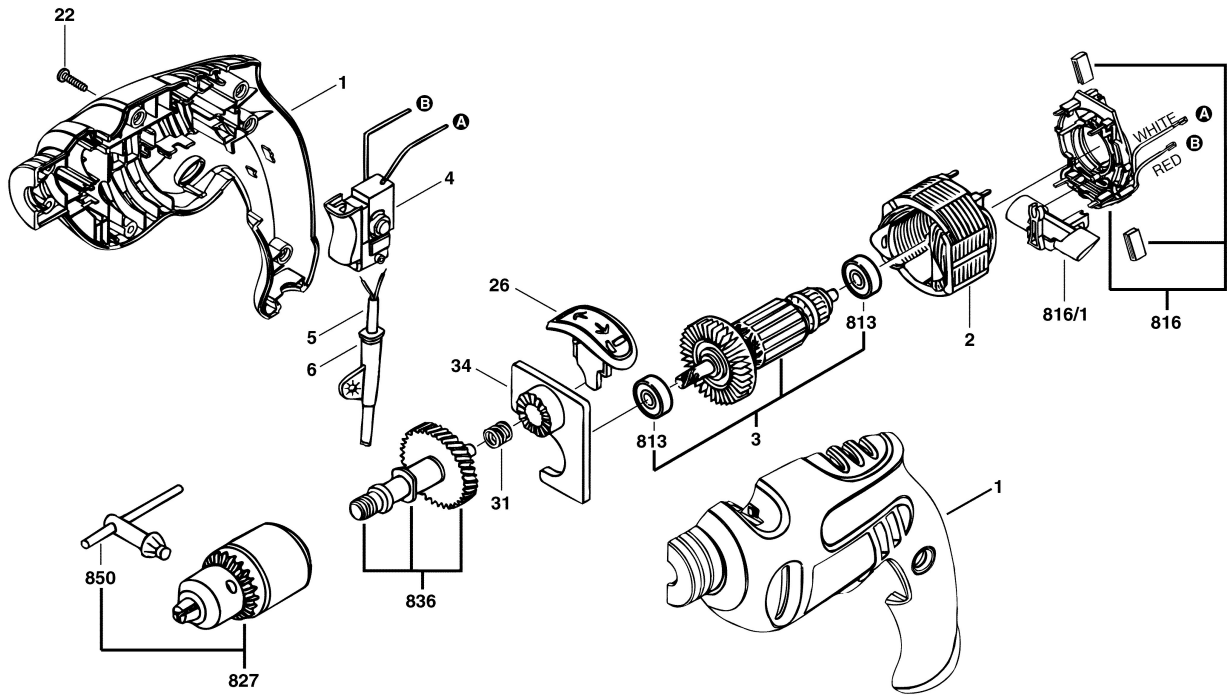

Änderungen vorbehalten  
Modifications reserved  
Modifications reserves  
Salvo modificaciones