

F 015 637 5A1

Stand 1
Issue J 02-10-01

Abb./Fig. 1

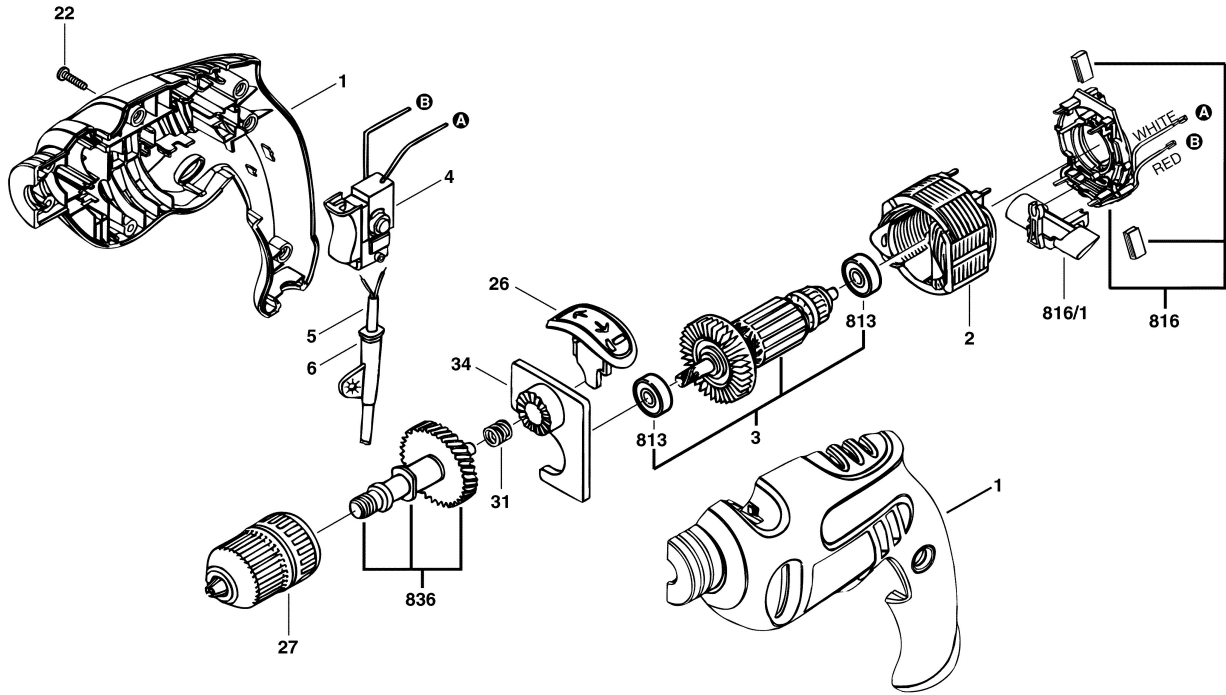

Änderungen vorbehalten
Modifications reserved
Modifications reserves
Salvo modificaciones