

F 015 638 001

Stand 04-05
Issue 06-07-14

Abb./Fig. 1

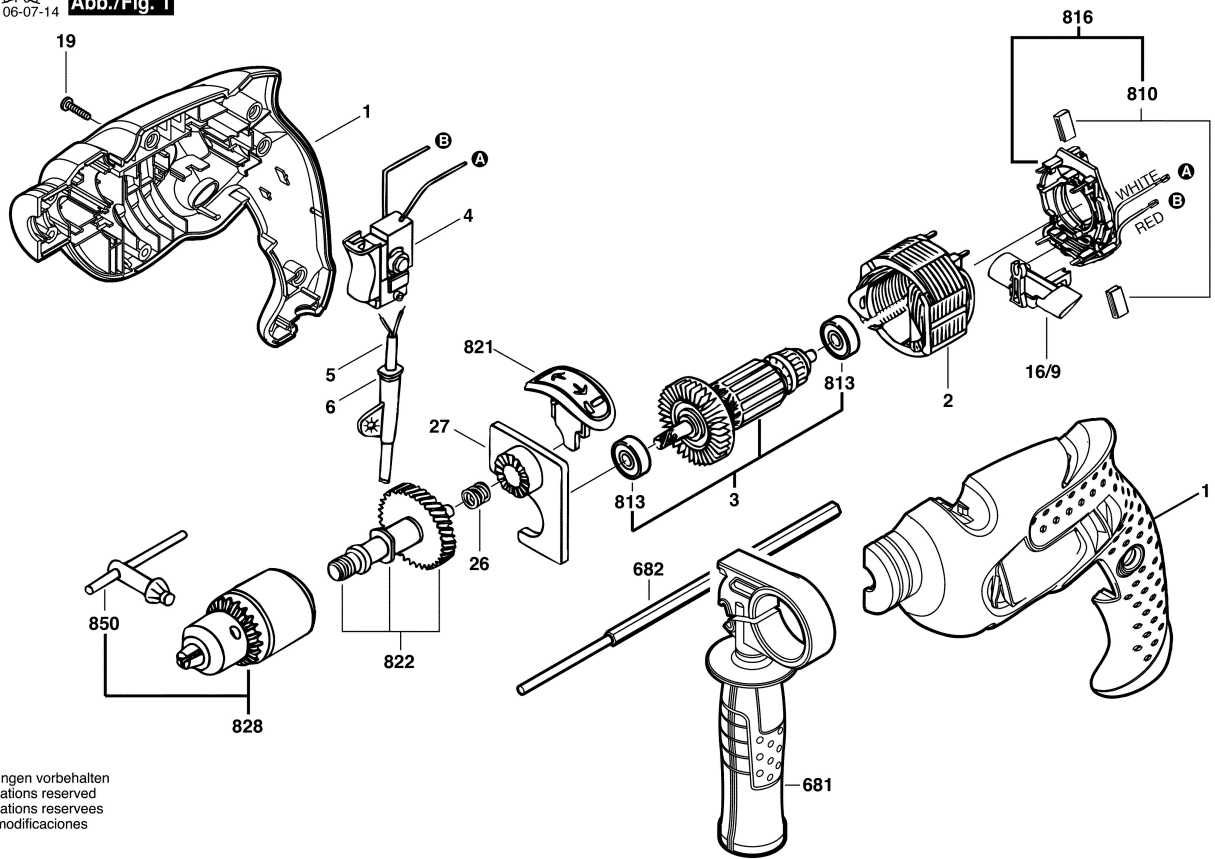

Änderungen vorbehalten
Modifications reserved
Modifications reserves
Salvo modificaciones