

F 015 638 301

Stand 05-10-19
Issue

Abb./Fig. 1

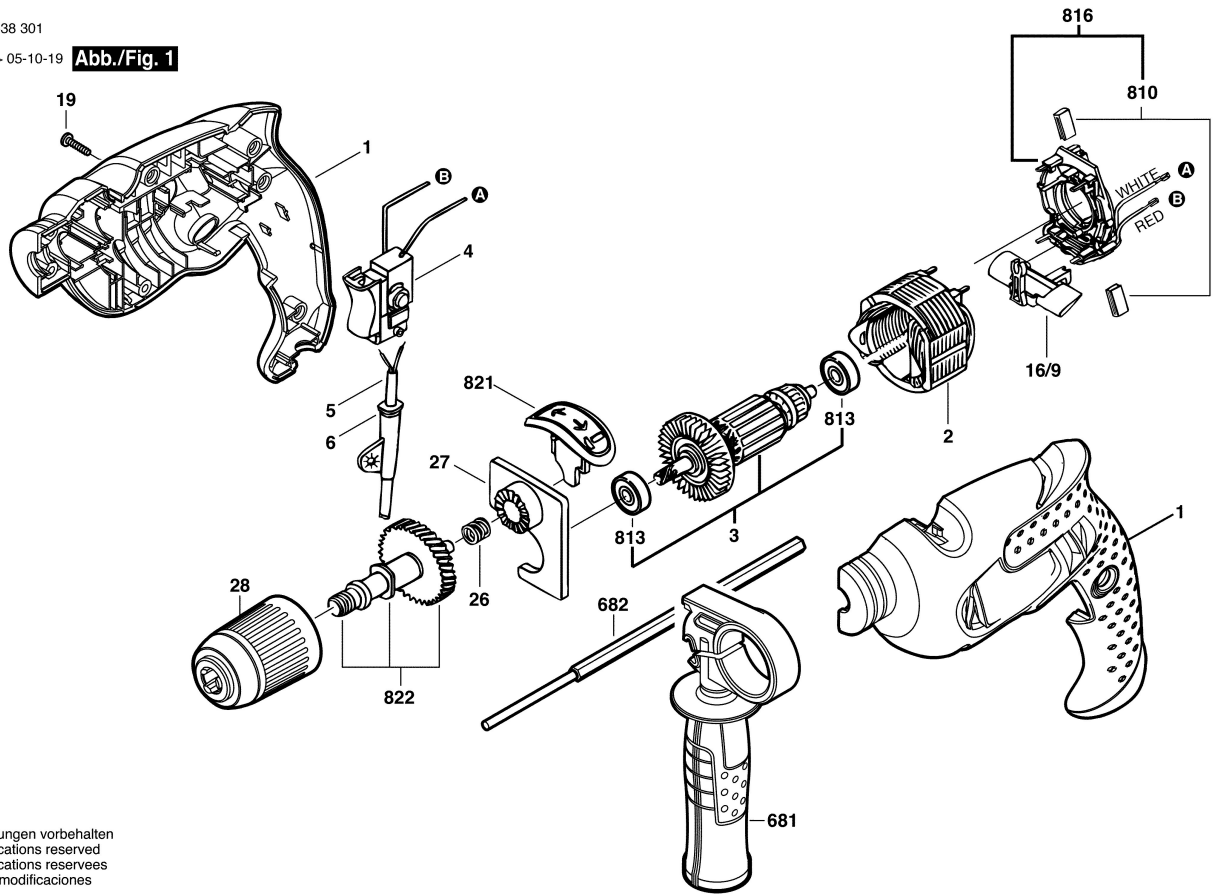

Änderungen vorbehalten
Modifications reserved
Modifications reserves
Salvo modificaciones