

F 015 638 501

Stand 04-05
Issue 05-10-19

Abb./Fig. 1

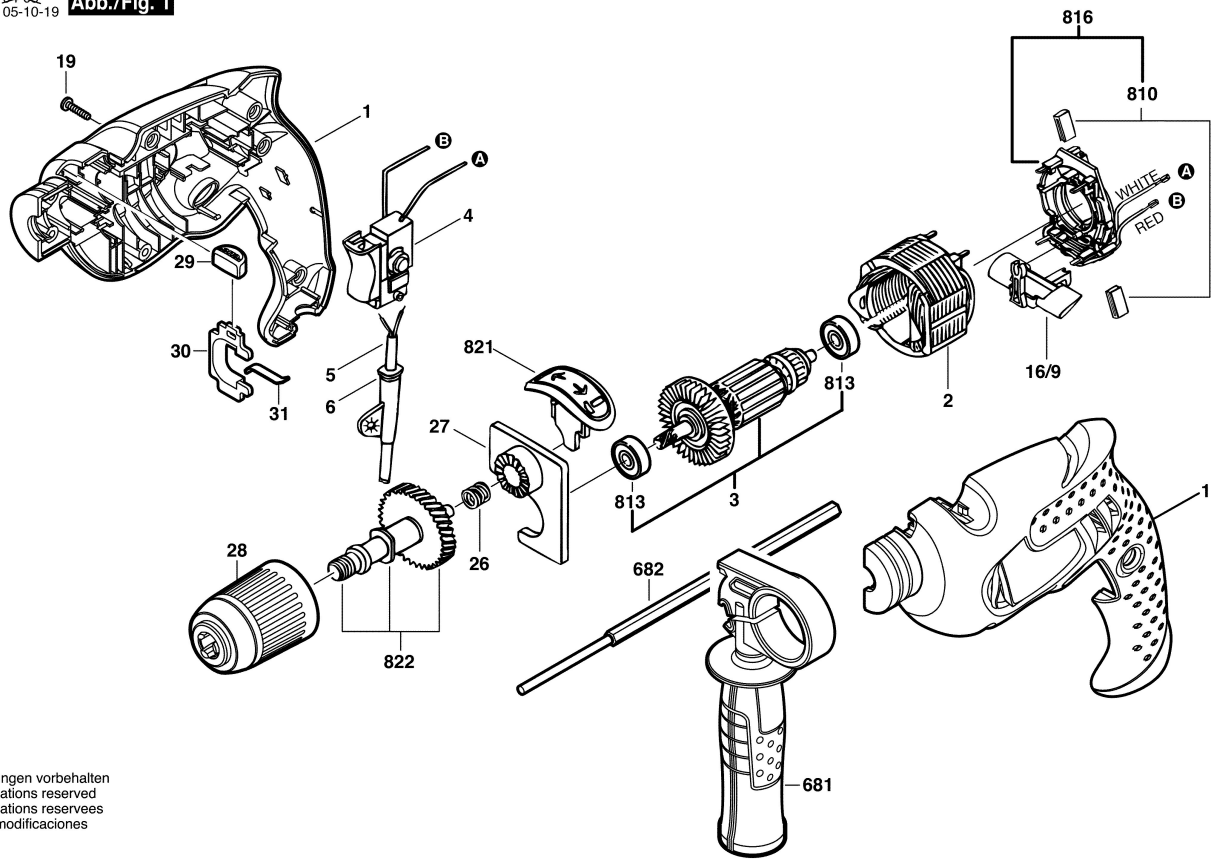

Änderungen vorbehalten
Modifications reserved
Modifications reserves
Salvo modificaciones