

F 015 648 001

Stand | 08-05

Issue | 11-02-04

Fig. /Abb. 1

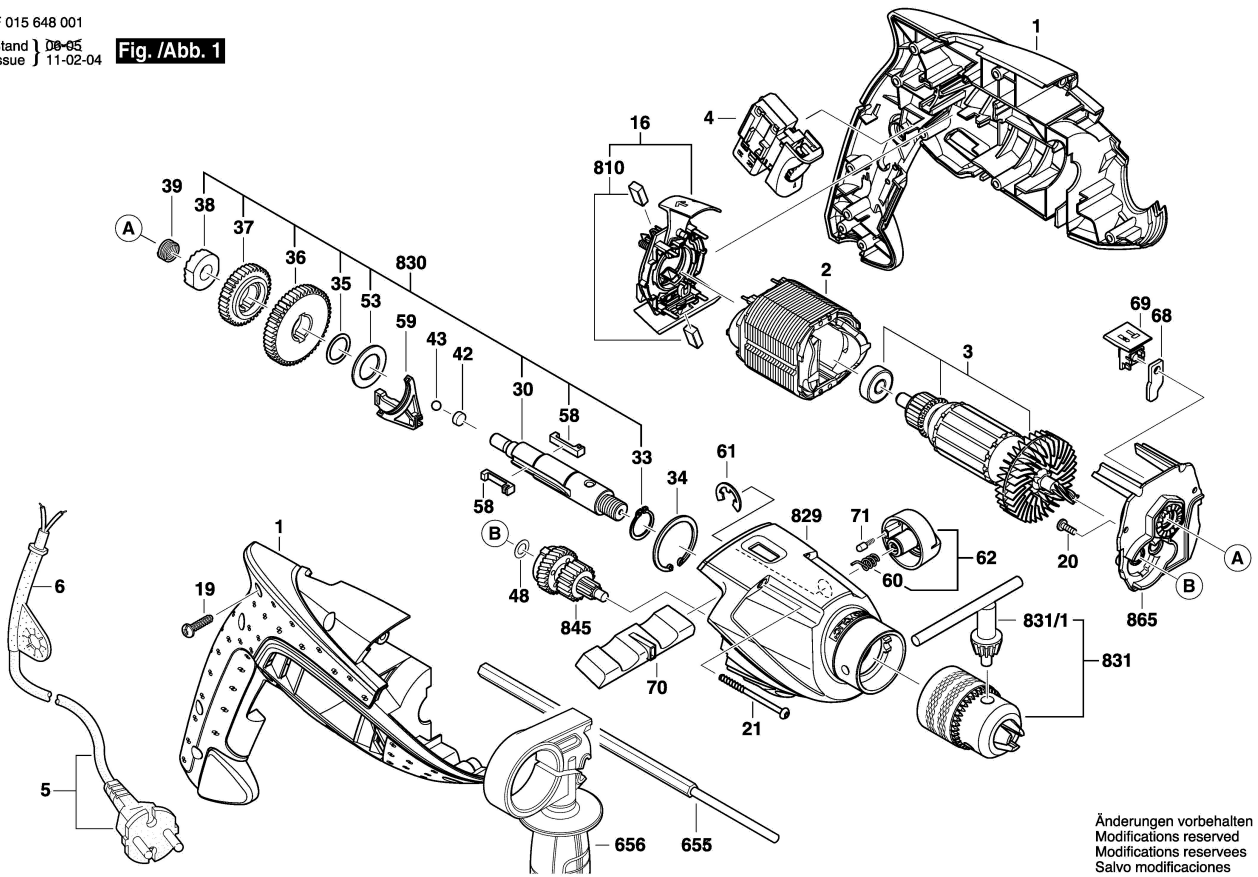

Änderungen vorbehalten
Modifications reserved
Modificaciones reservées
Salvo modificaciones