

F 015 650 211

Stand 10-05-31
Issue 10-05-31

Fig./Abb. 1

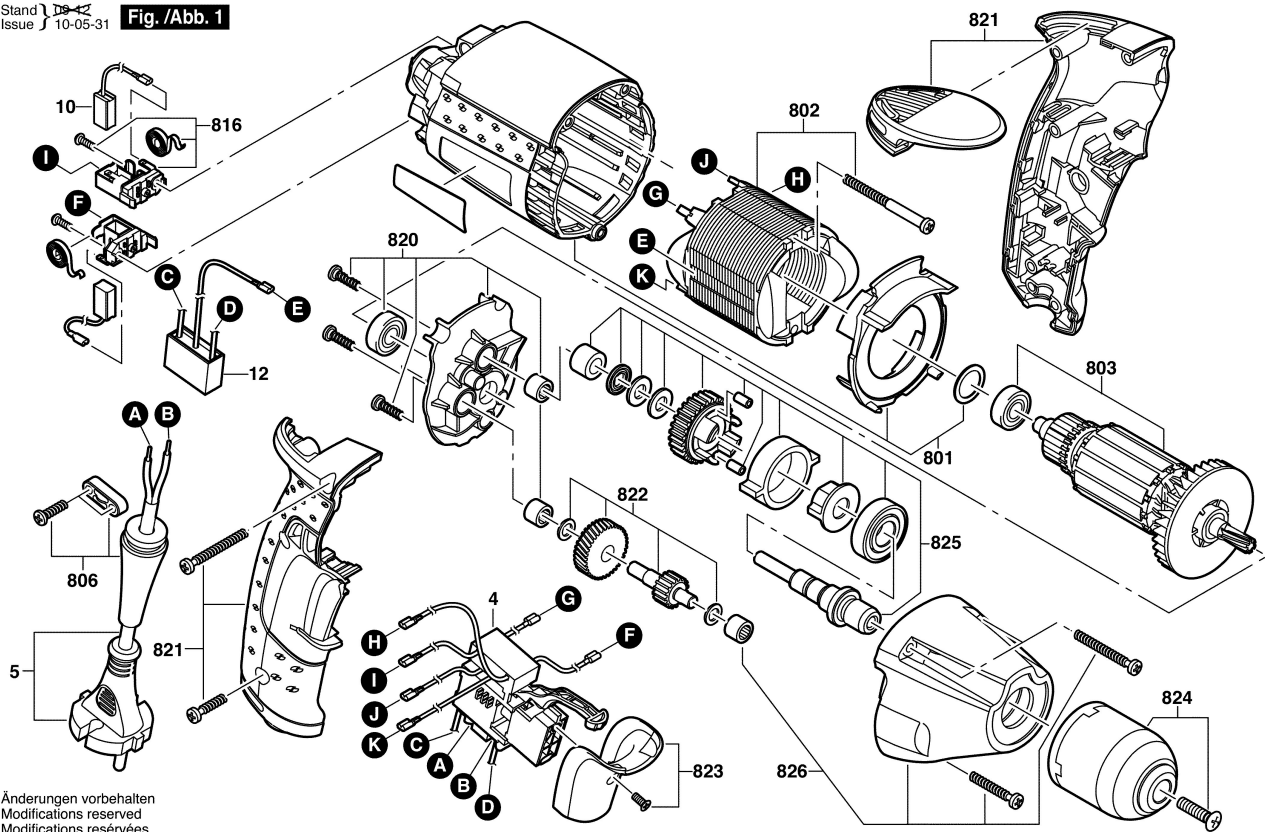

Änderungen vorbehalten
Modifications reserved
Modifications réservées
Salvo modificaciones