

F 015 651 021
Stand | 13-09
Issue | 13-10-14

Fig./Abb. 1

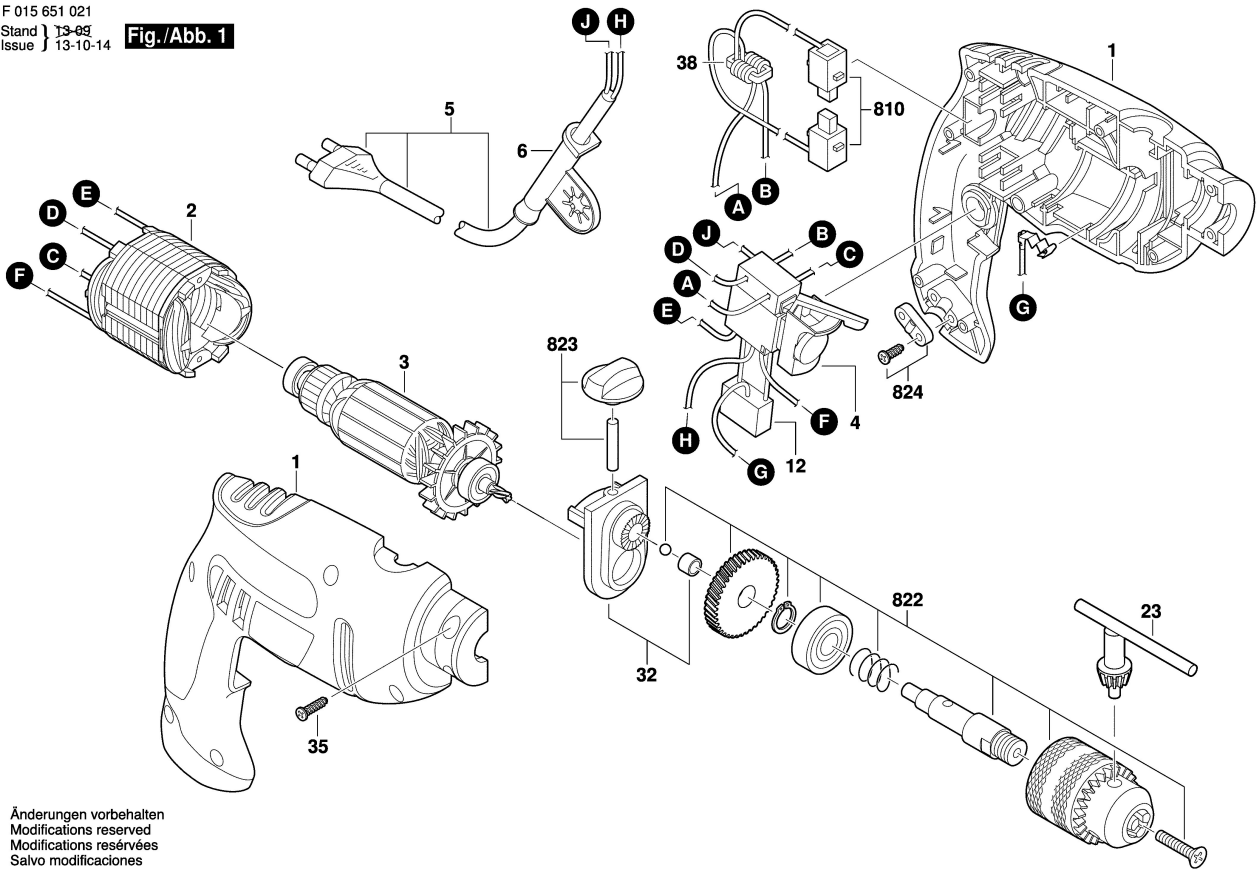

Änderungen vorbehalten
Modifications reserved
Modifications réservées
Salvo modificaciones