

F 015 678 001
Stand 10-11
Issue 06-01-19

Fig./Abb. 1

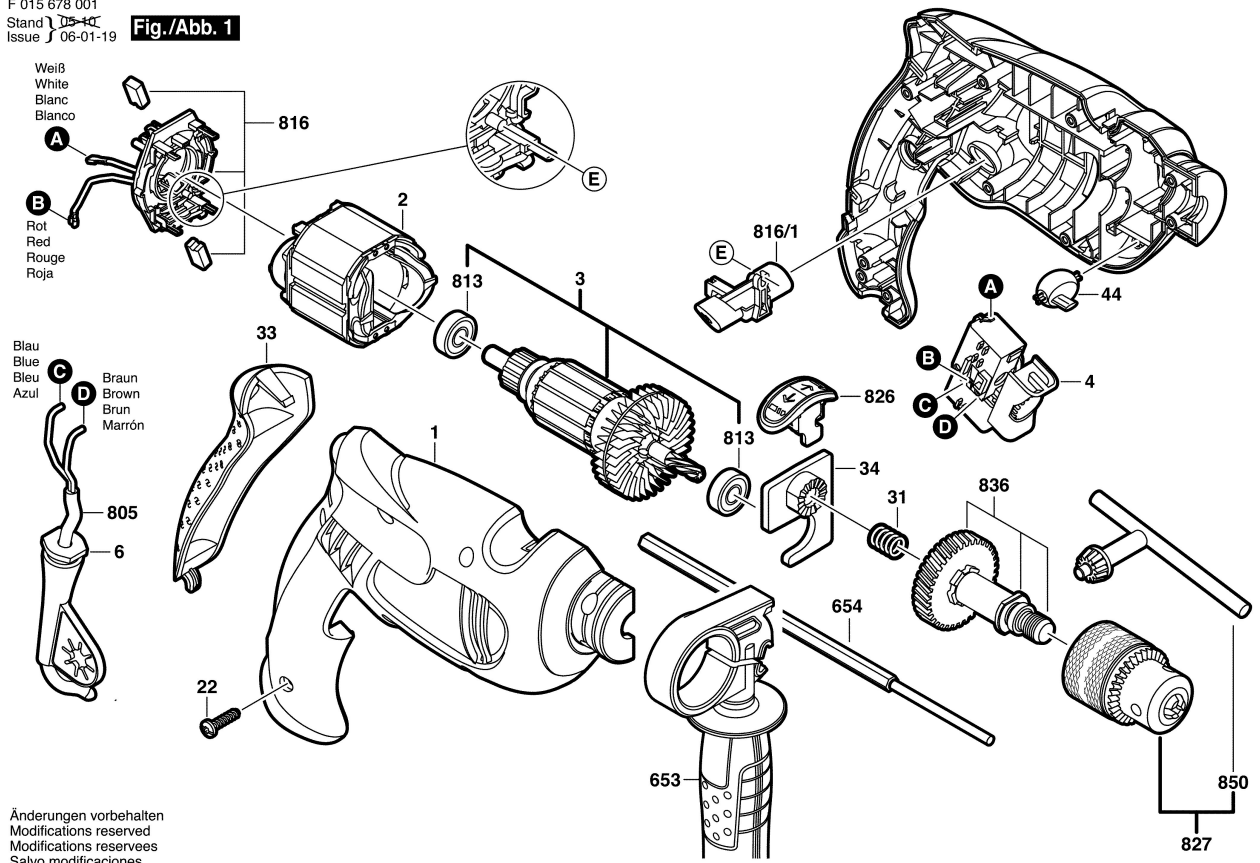

Änderungen vorbehalten
Modifications reserved
Modificaciones reservadas
Salvo modificaciones