

F 015 690 101
Stand | D8-42
Issue | 09-05-08

Fig./Abb. 1

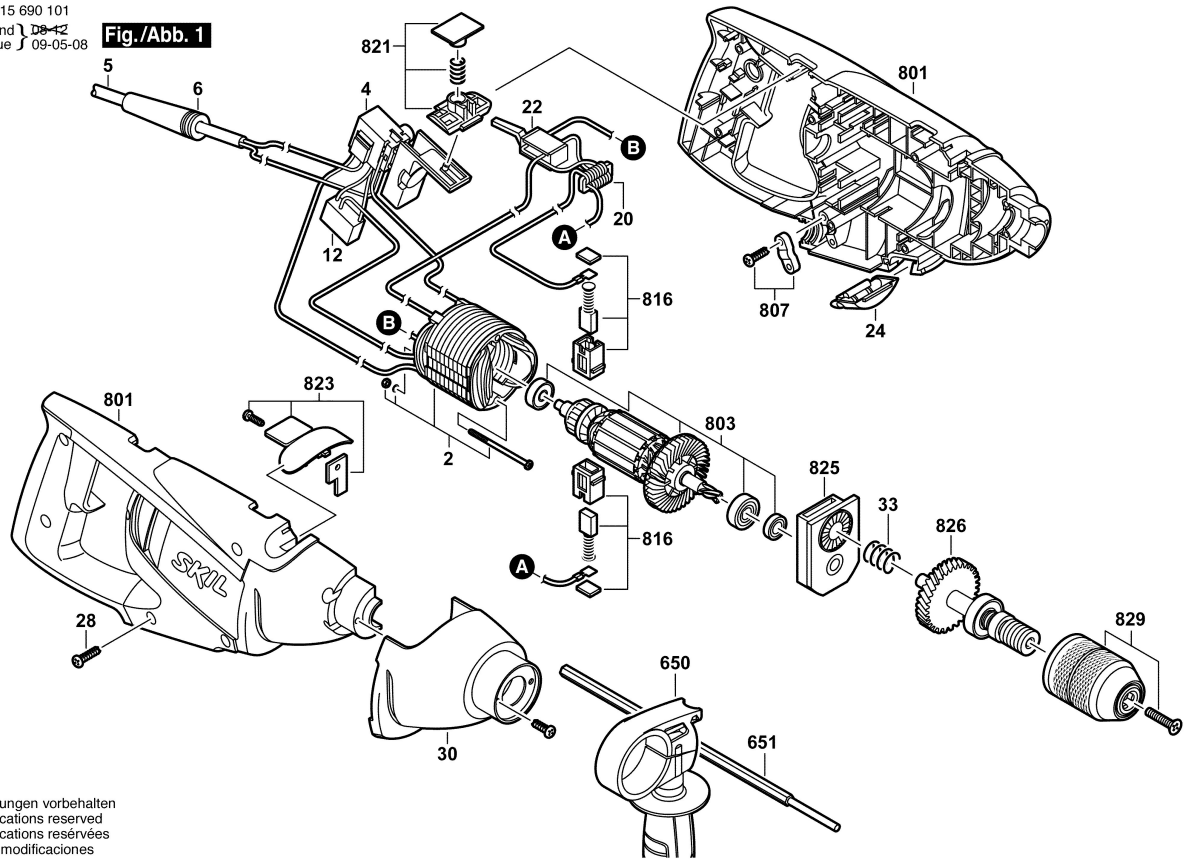

Änderungen vorbehalten
Modifications reserved
Modifications réservées
Salvo modificaciones