

F 015 690 101  
Stand 10-12  
Issue 09-05-08

**Fig./Abb. 1**

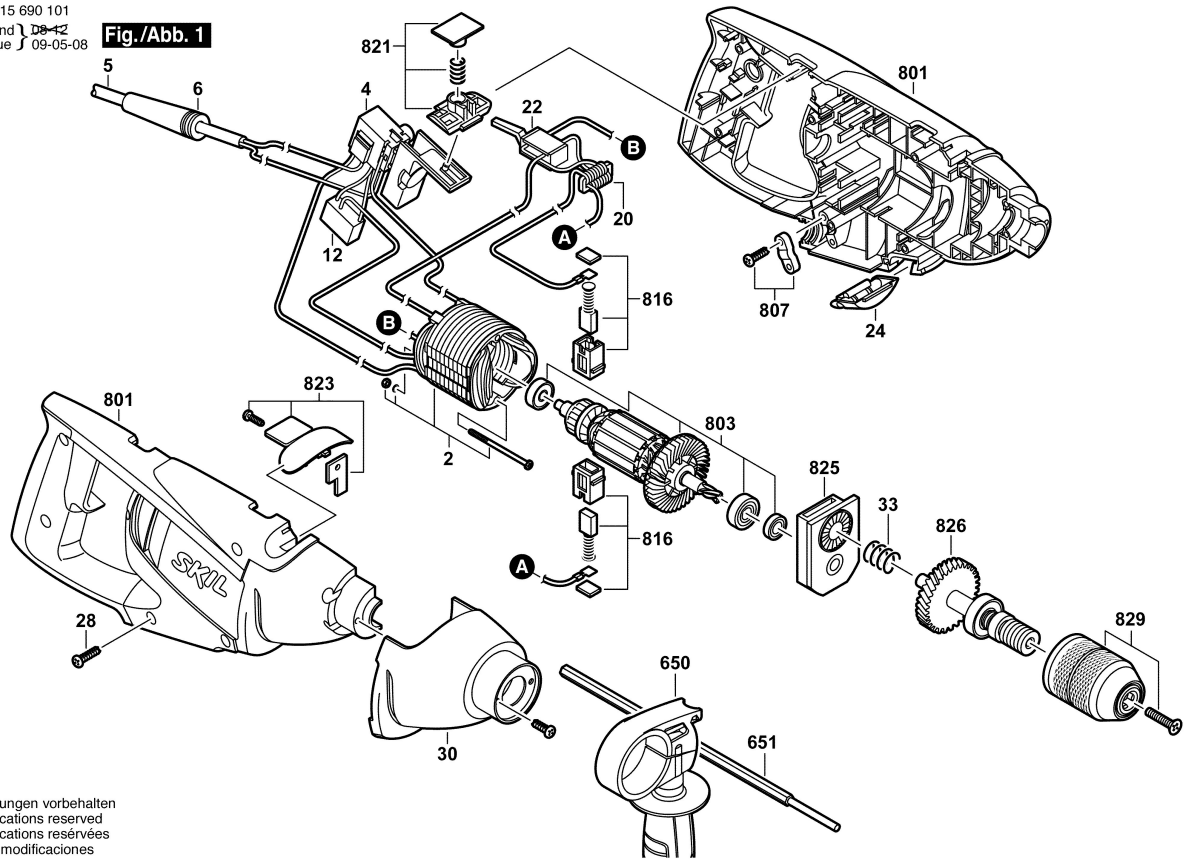

Änderungen vorbehalten  
Modifications reserved  
Modifications réservées  
Salvo modificaciones