

F 015 692 511

Stand 10-12-07
Issue 10-05-28

Fig./Abb. 1

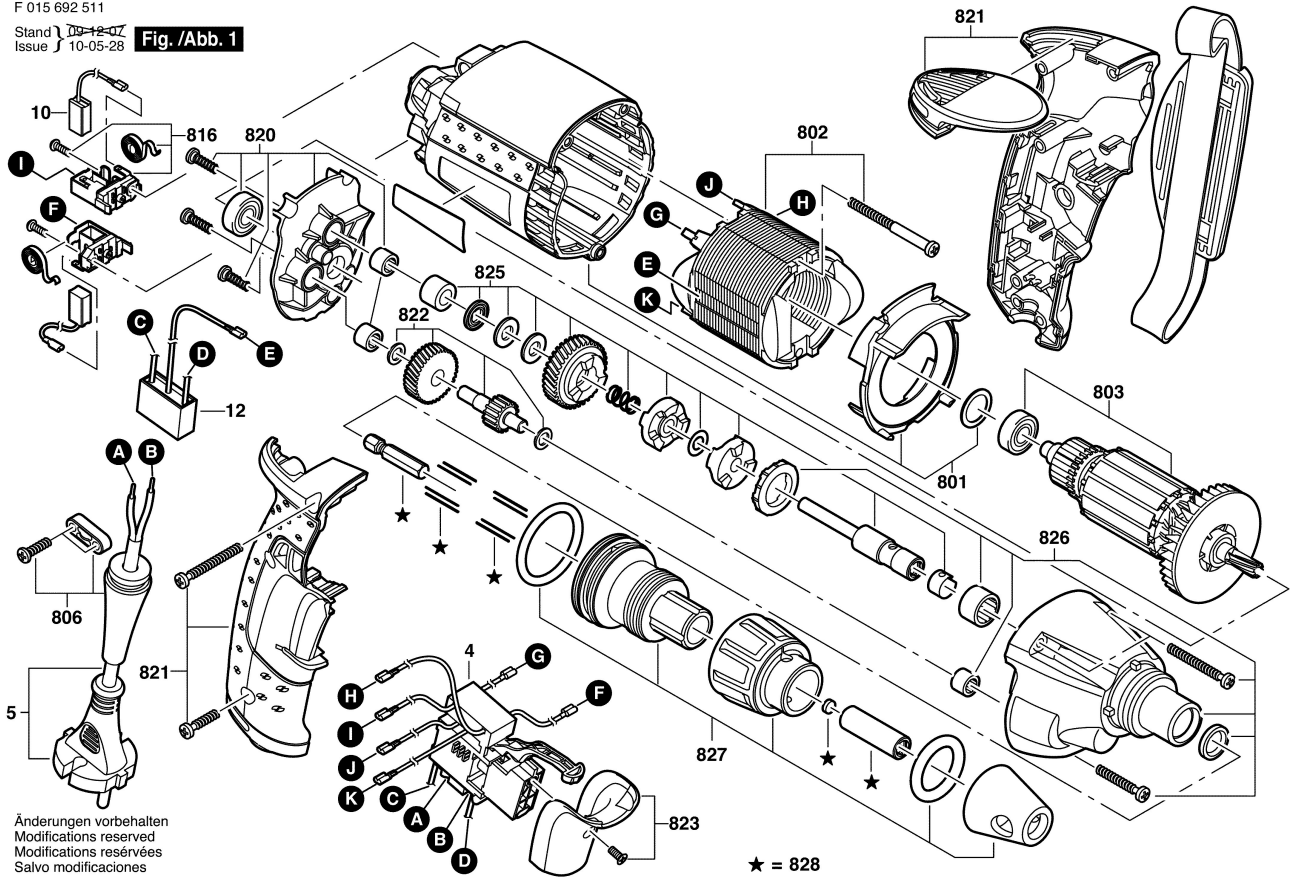

Änderungen vorbehalten
Modifications reserved
Modifications réservées
Salvo modificaciones