

F 015 720 801
Stand 04-10-22
Issue J

Fig./Abb. 1

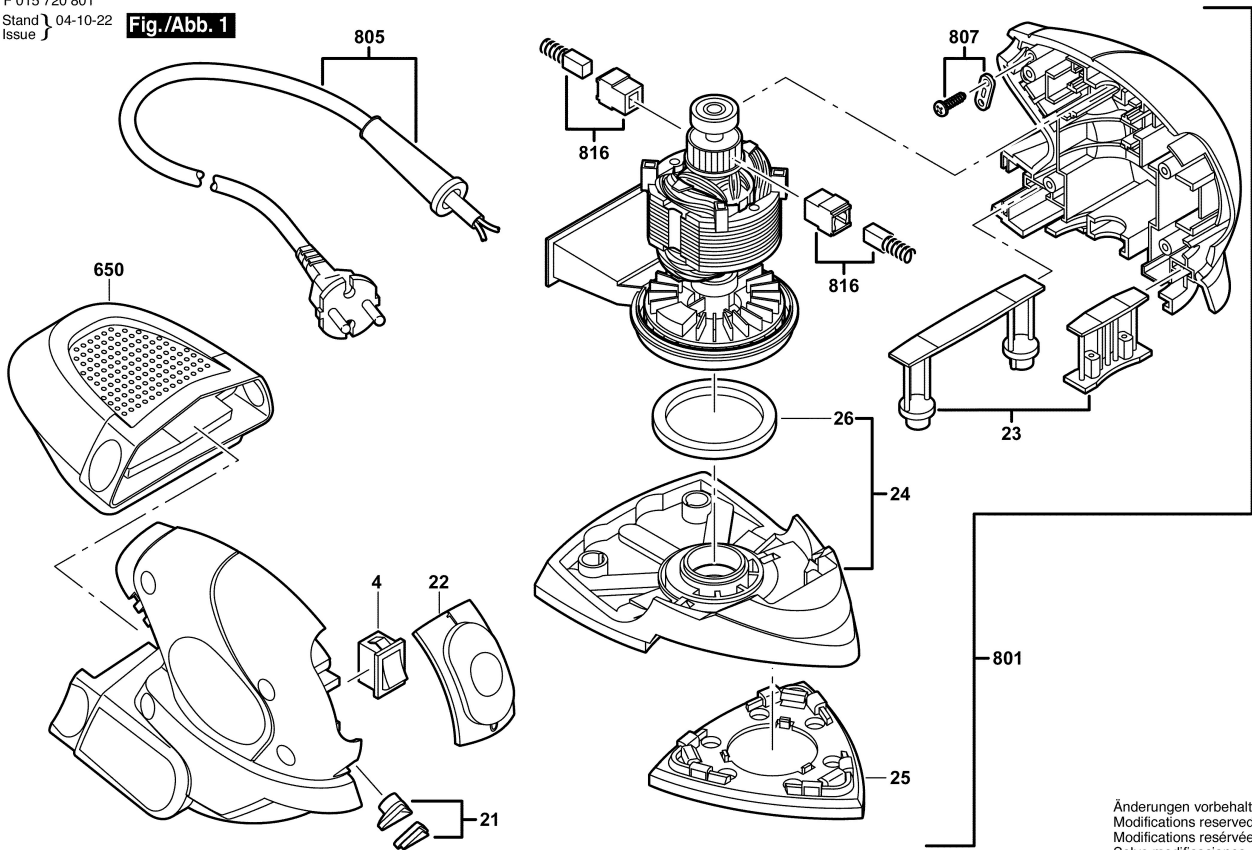

Änderungen vorbehalten
Modifications reserved
Modifications réservées
Salvo modificaciones