

F 015 722 001

Stand | 13-09-18
Issue | 13-03-22

Fig./Abb. 1

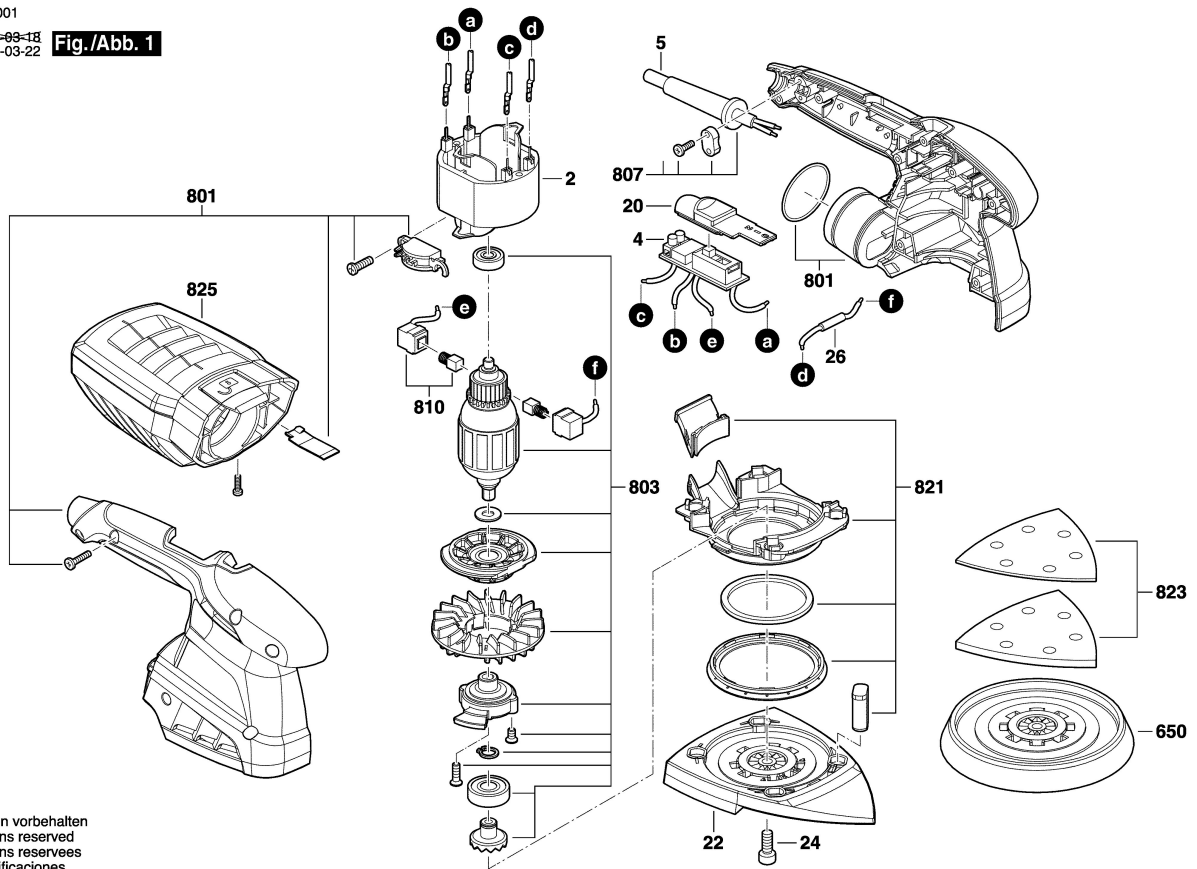

Änderungen vorbehalten
Modifications reserved
Modifications reserves
Salvo modificaciones