

F 015 722 601

Stand | 17-04-03
Issue | 14-04-16

Fig./Abb. 1

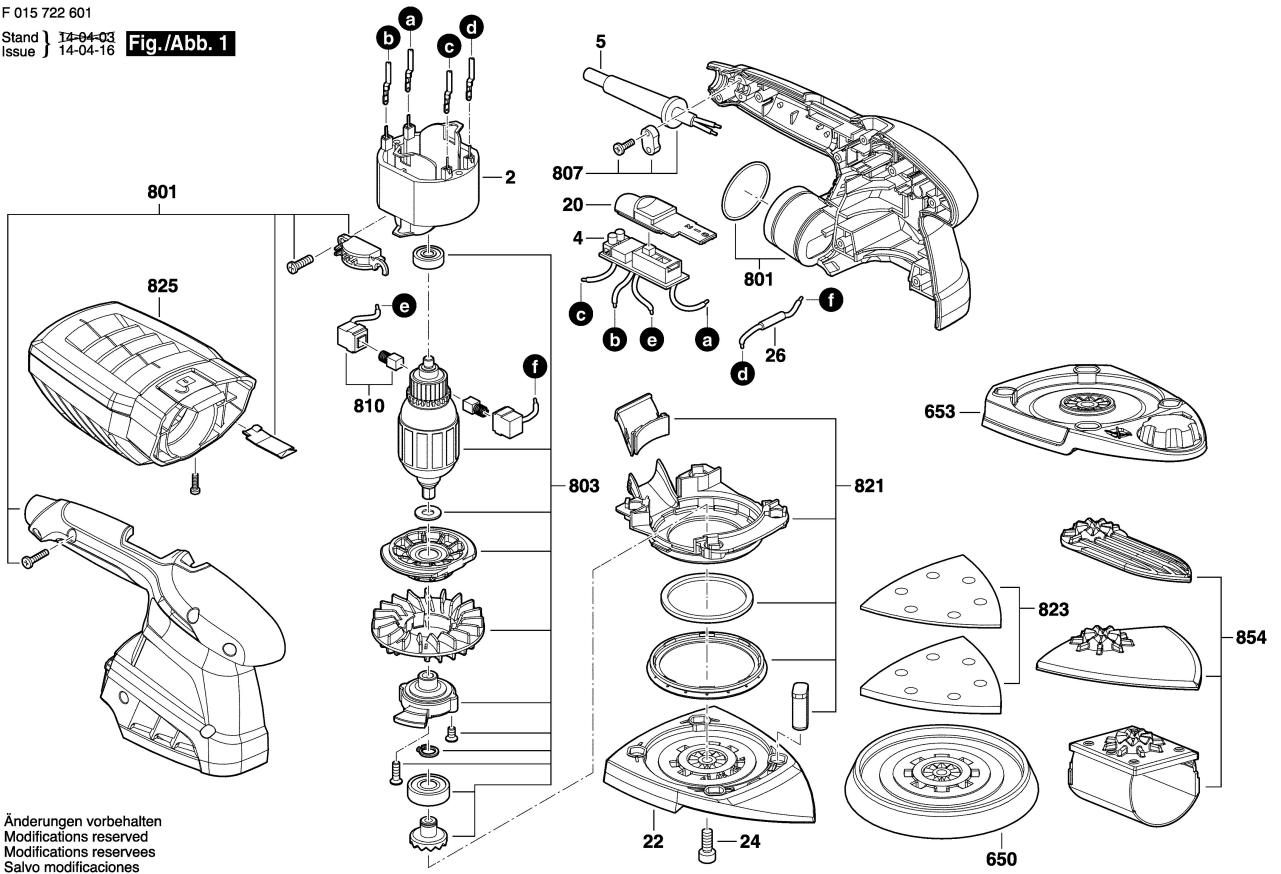

Änderungen vorbehalten
Modifications reserved
Modifications reserves
Salvo modificaciones