

F 015 734 601

Stand 09-09-24
Issue J

Fig./Abb. 1

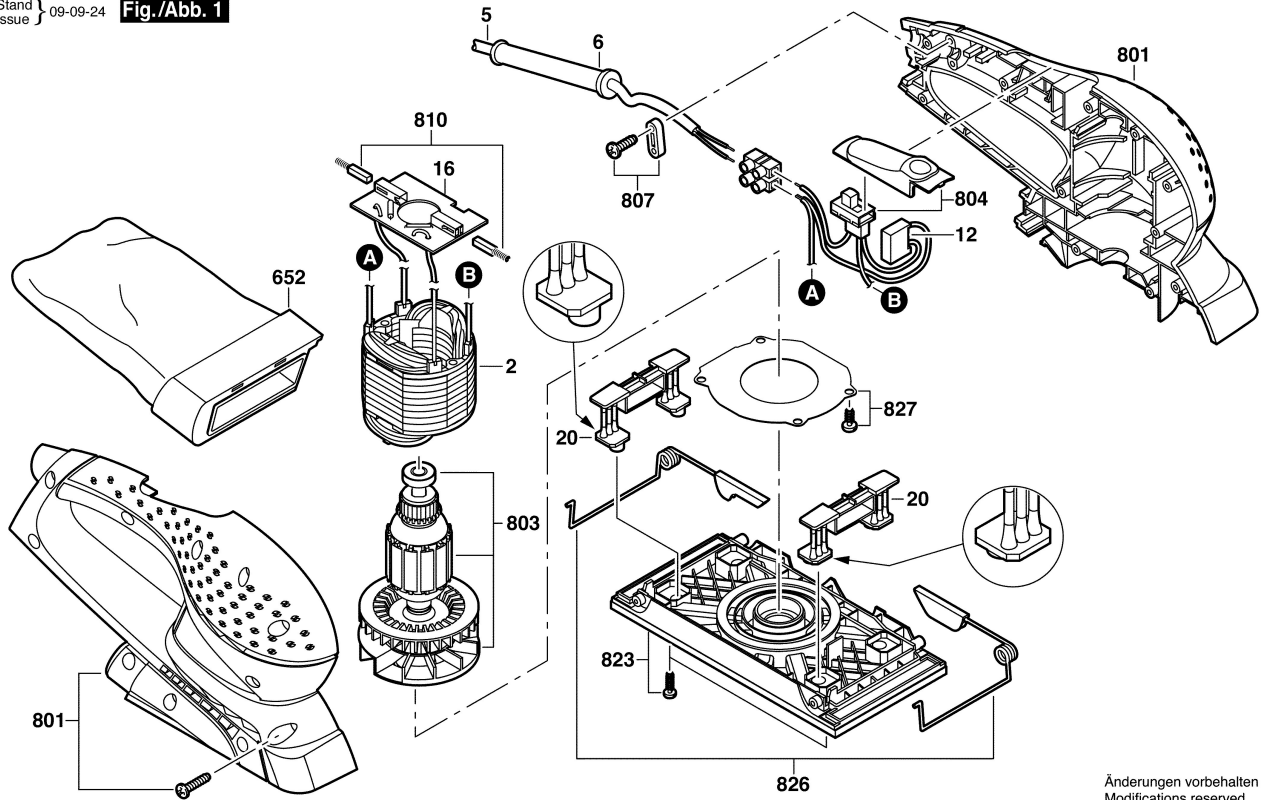

Änderungen vorbehalten
Modifications reserved
Modifications réservées
Salvo modificaciones