

F 015 734 801
Stand | 13-10-08
Issue | 13-10-21

Fig./Abb. 1

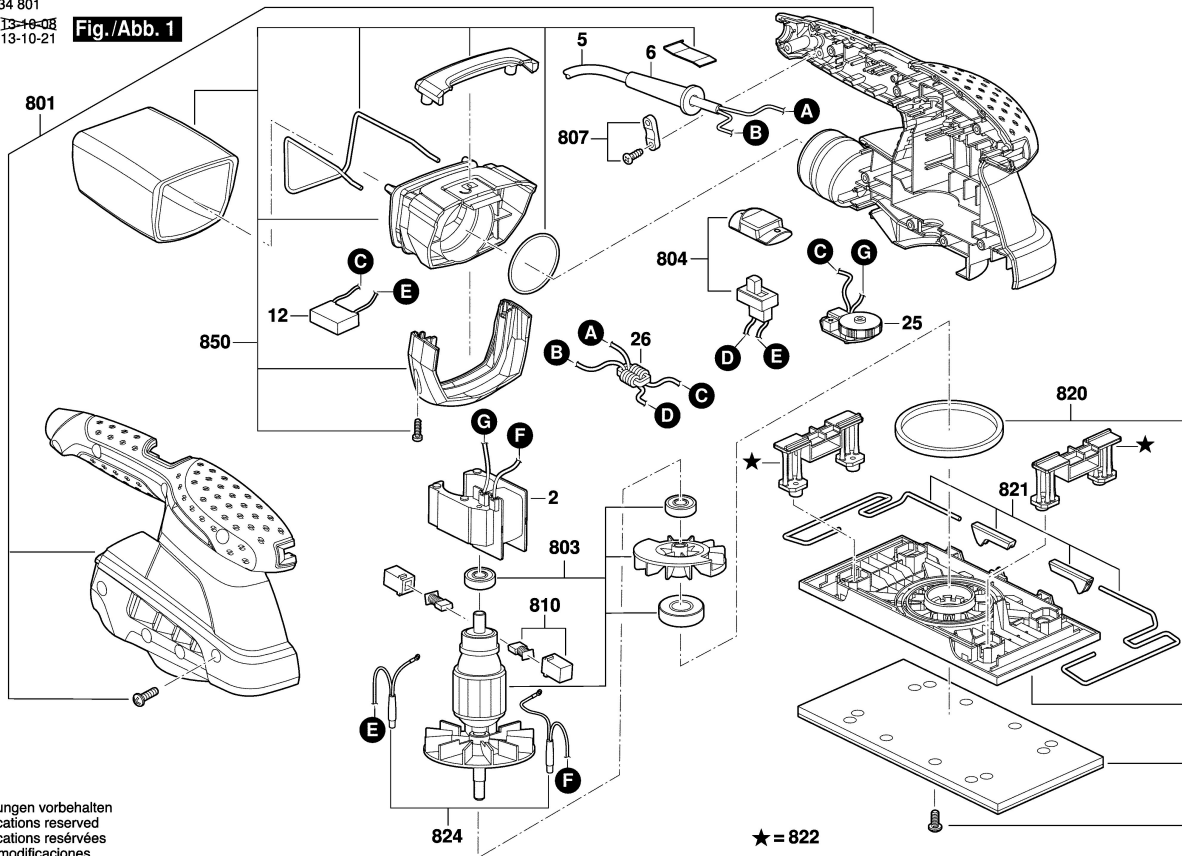

Änderungen vorbehalten
Modifications reserved
Modifications réservées
Salvo modificaciones