

F 015 744 001
 Stand | 07-01
 Issue | 13-09-18

Fig./Abb. 1

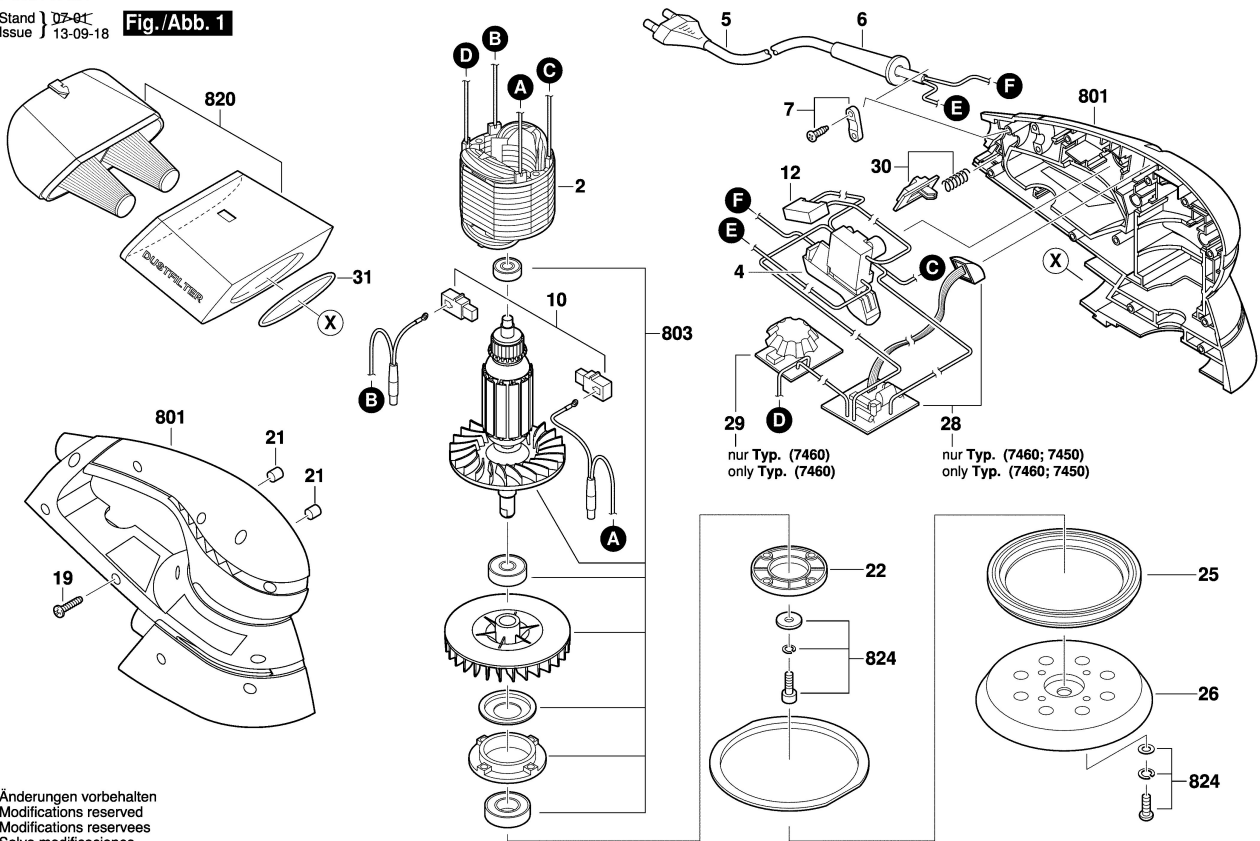

Änderungen vorbehalten
 Modifications reserved
 Modifications reserves
 Salvo modificaciones