

F 015 763 001
Stand 05-12-02
Issue 06-02-28

Fig./Abb. 1

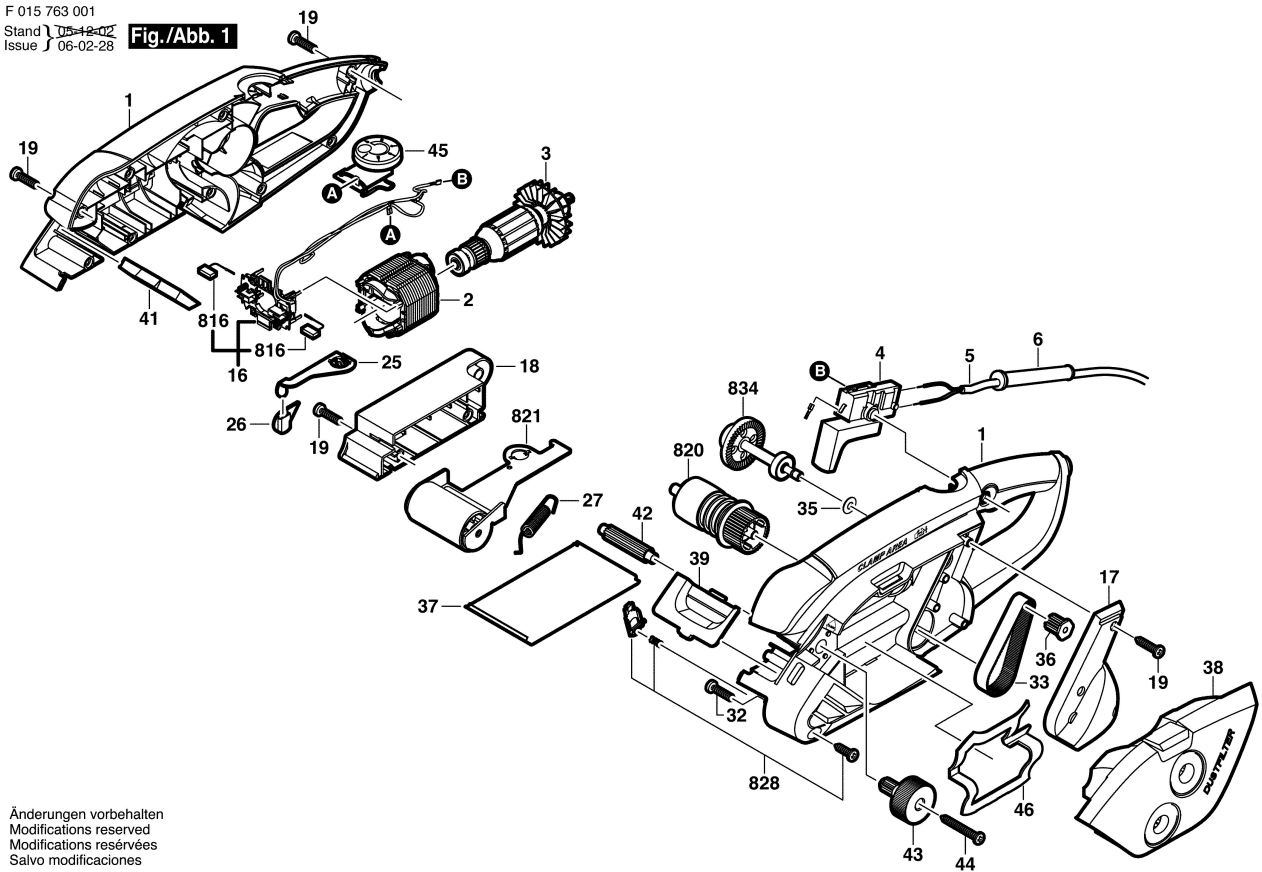

Änderungen vorbehalten
Modifications reserved
Modifications réservées
Salvo modificaciones