

F 015 763 001  
Stand 05-12-02  
Issue 06-02-28

**Fig./Abb. 1**

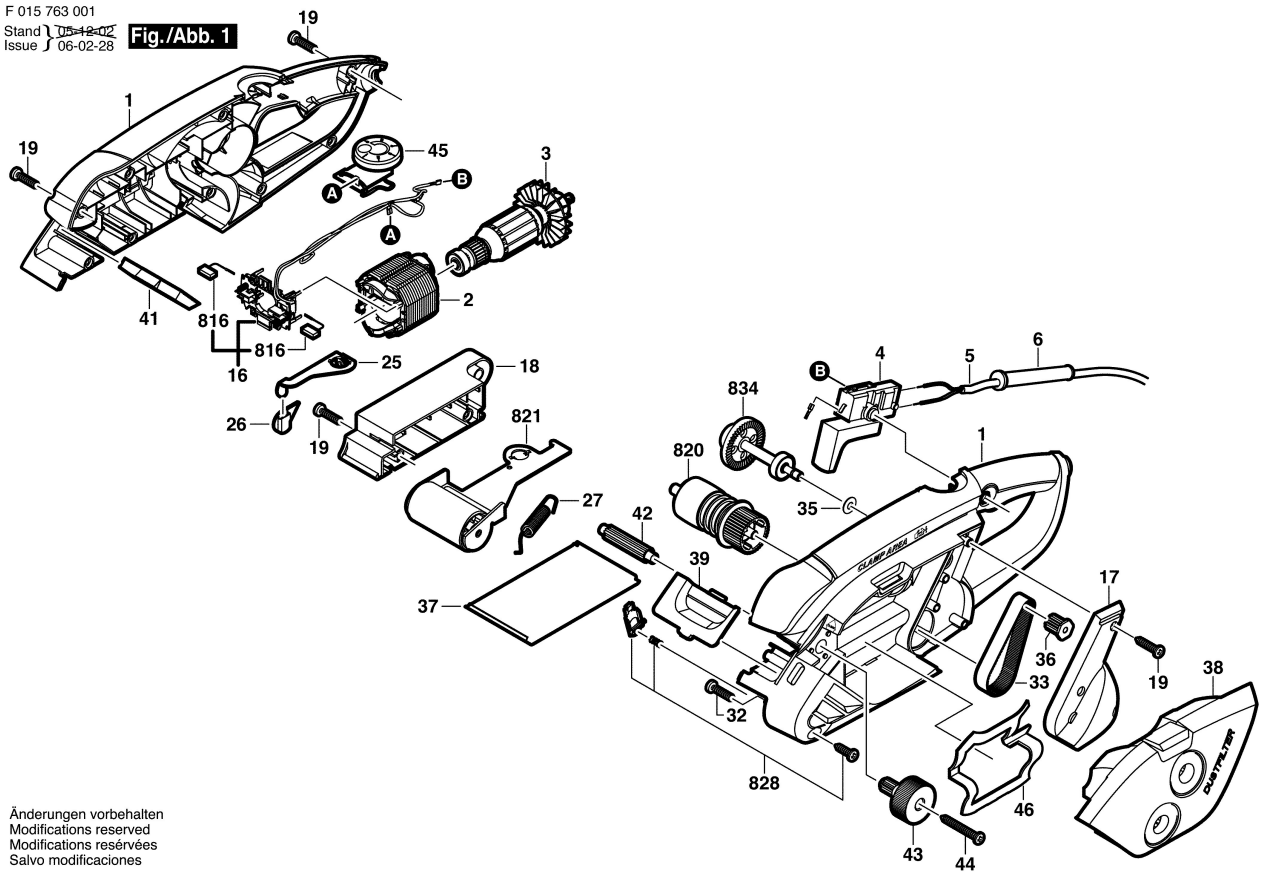

Änderungen vorbehalten  
Modifications reserved  
Modifications réservées  
Salvo modificaciones