

F 015 765 001
Stand 08-09-12
Issue J

Fig./Abb. 1

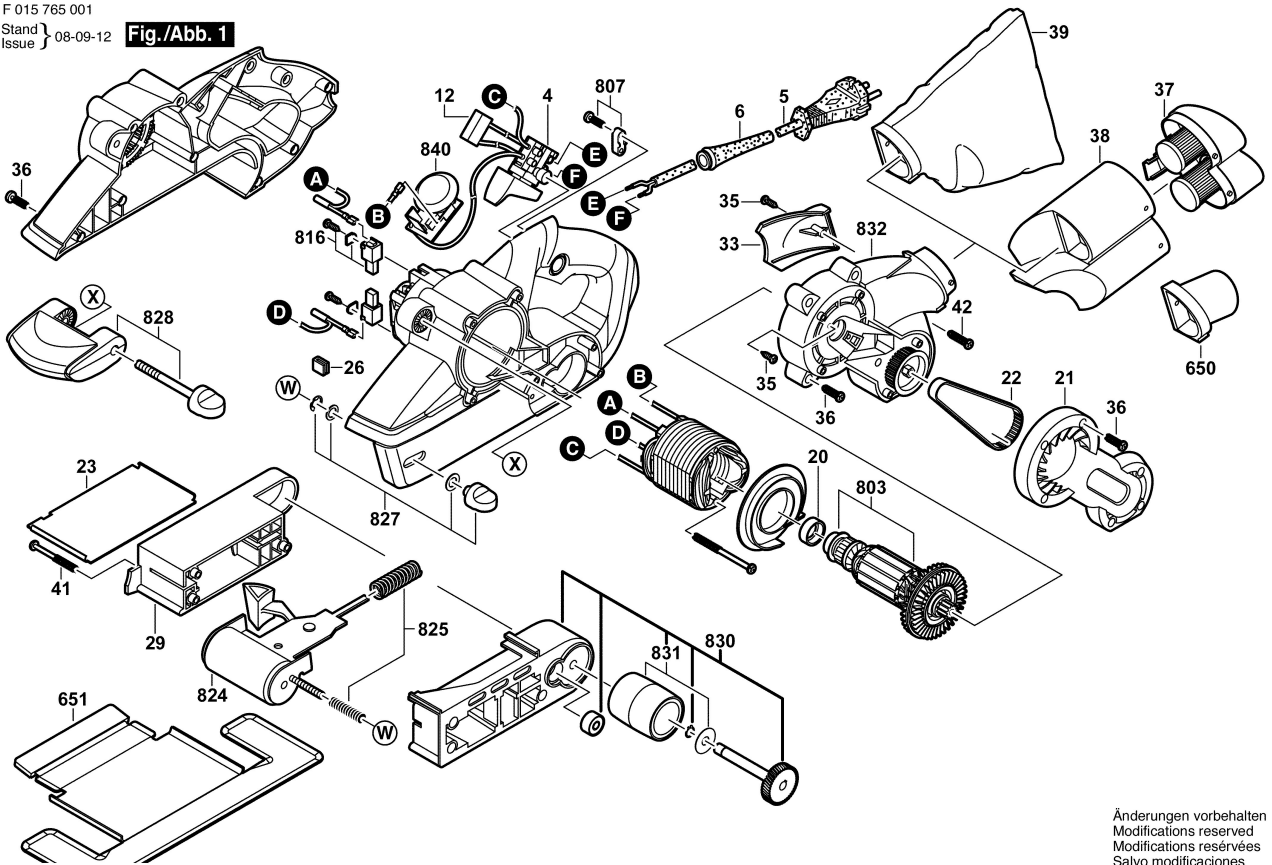

Änderungen vorbehalten
Modifications reserved
Modifications réservées
Salvo modificaciones