

F 015 900 301
Stand 104-10
Issue 06-05-02

Fig./Abb. 1

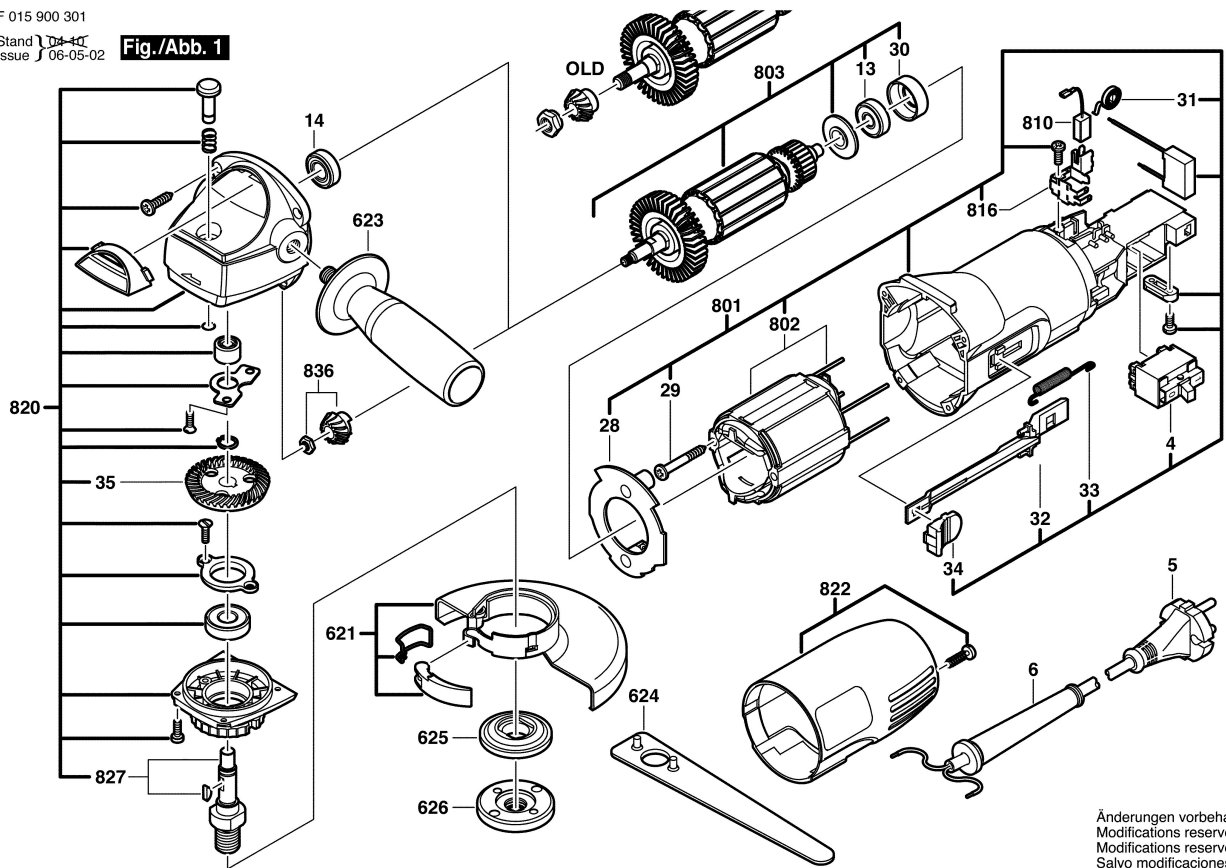

Änderungen vorbehalten
Modifications reserved
Modificaciones reservadas
Salvo modificaciones