

F 015 908 021
Stand }
Issue } 12-08-31

Fig./Abb. 1

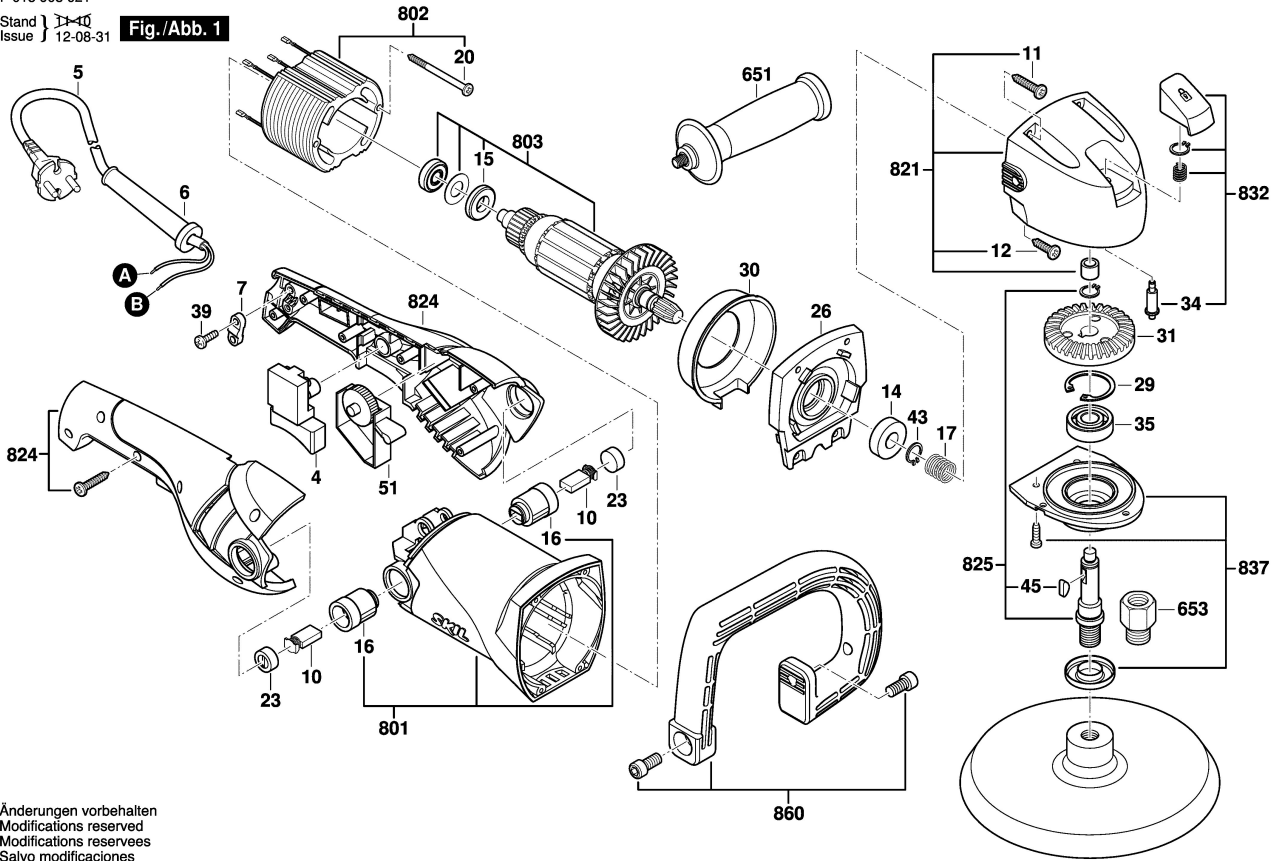

Änderungen vorbehalten
Modifications reserved
Modifications reserves
Salvo modificaciones