

F 015 908 021
Stand } 12-08-31
Issue }

Fig./Abb. 1

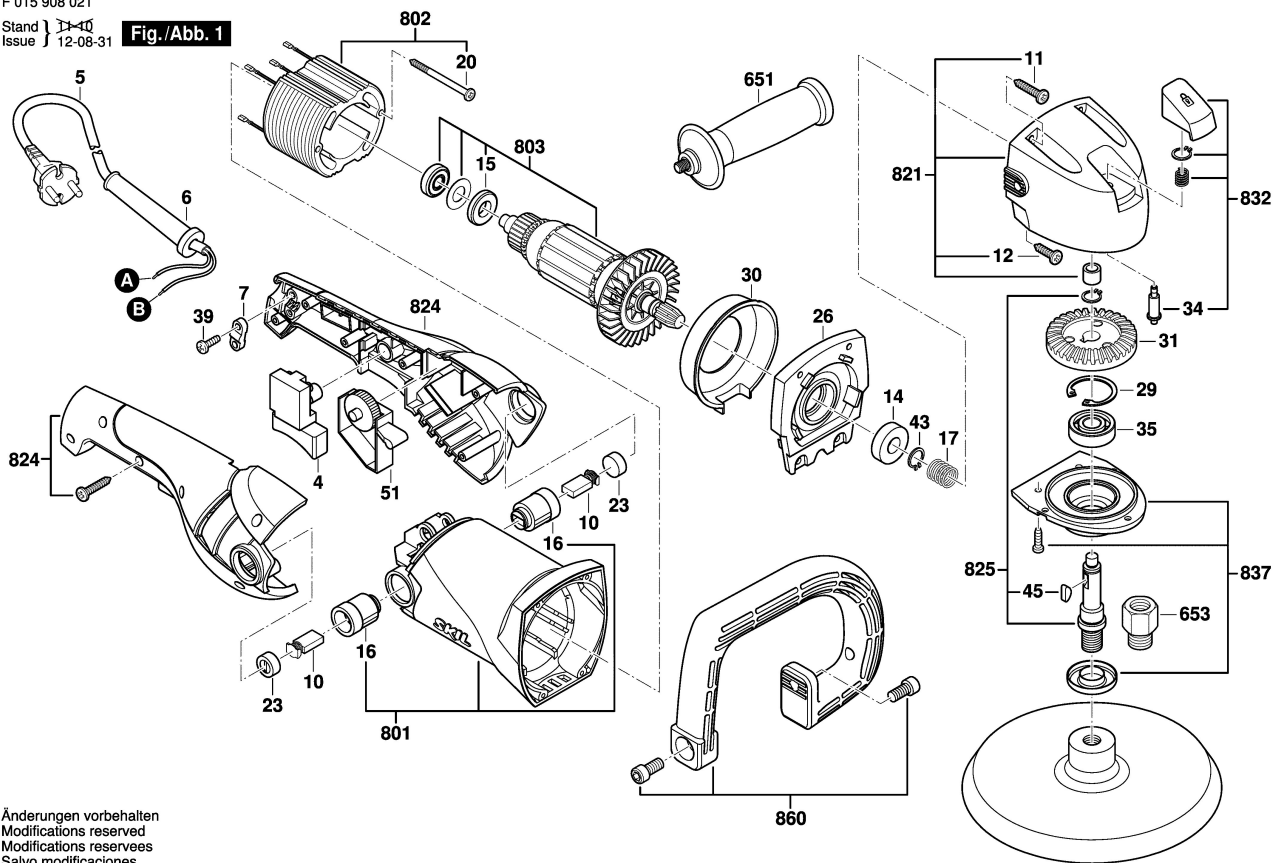

Änderungen vorbehalten
Modifications reserved
Modifications reserves
Salvo modificaciones