

F 015 908 223

Stand } 14-02-03
Issue }

Fig./Abb. 1

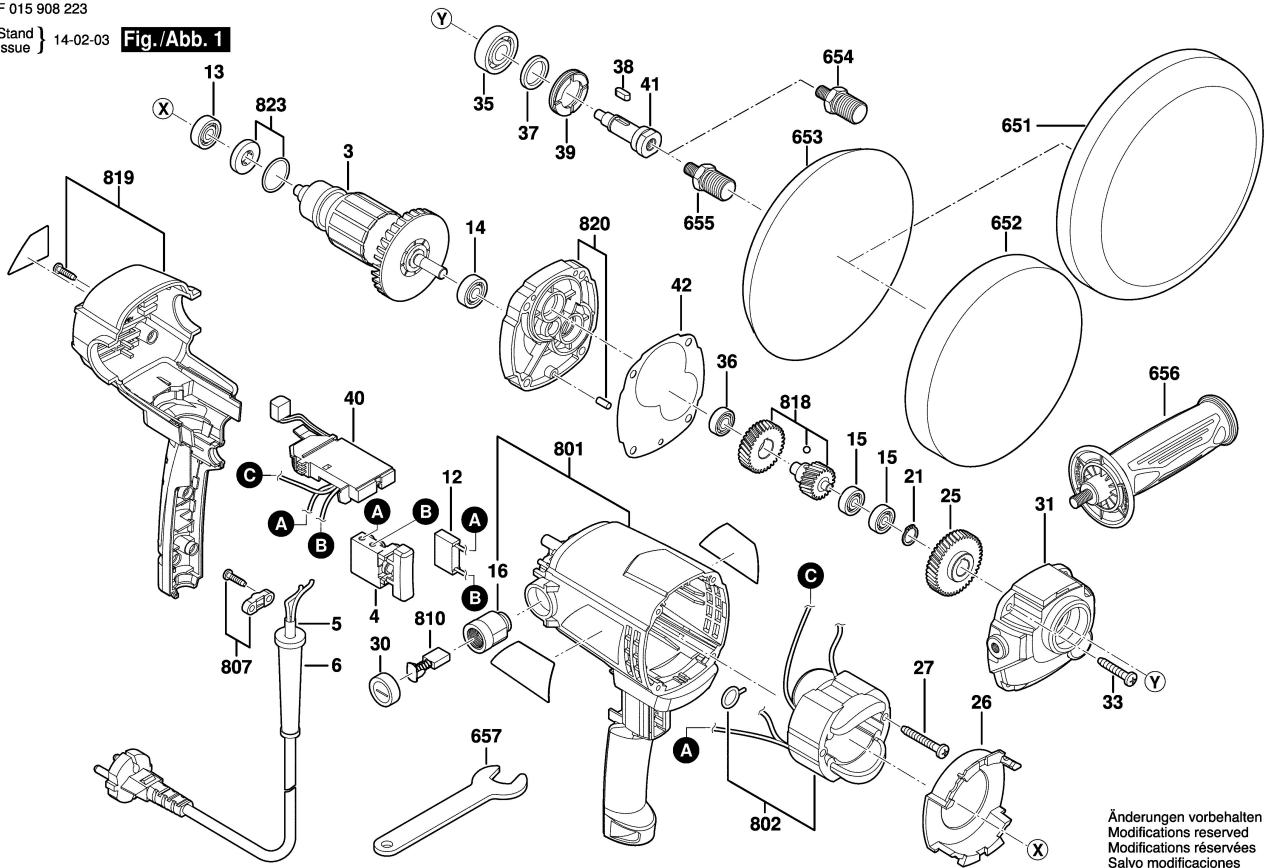

Änderungen vorbehalten
Modifications reserved
Modifications réservées
Salvo modificaciones