

F 015 914 001
Stand 08-91
Issue 06-06-02

Fig./Abb. 1

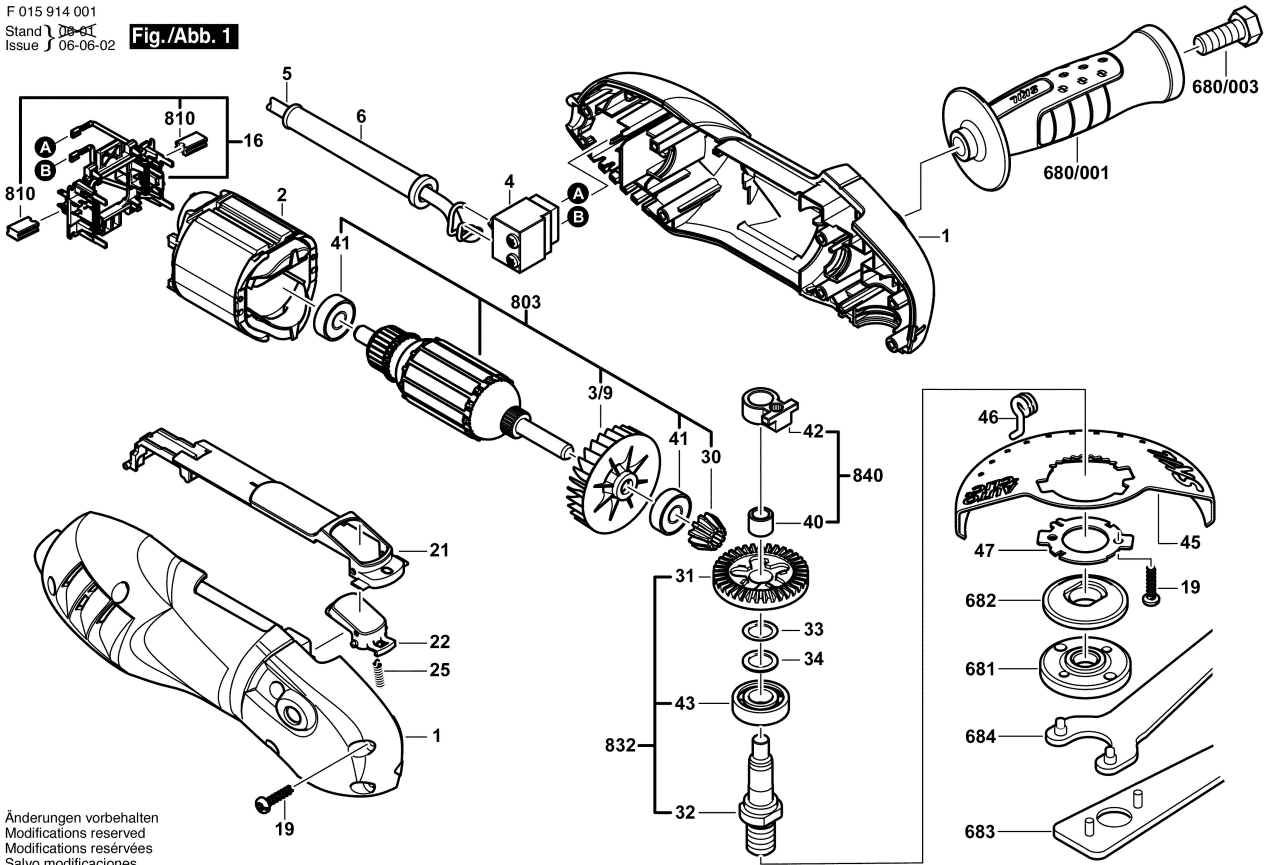

Änderungen vorbehalten
Modifications reserved
Modifications réservées
Salvo modificaciones