

F 015 914 501
 Stand 08-01
 Issue 06-06-02

Fig./Abb. 1

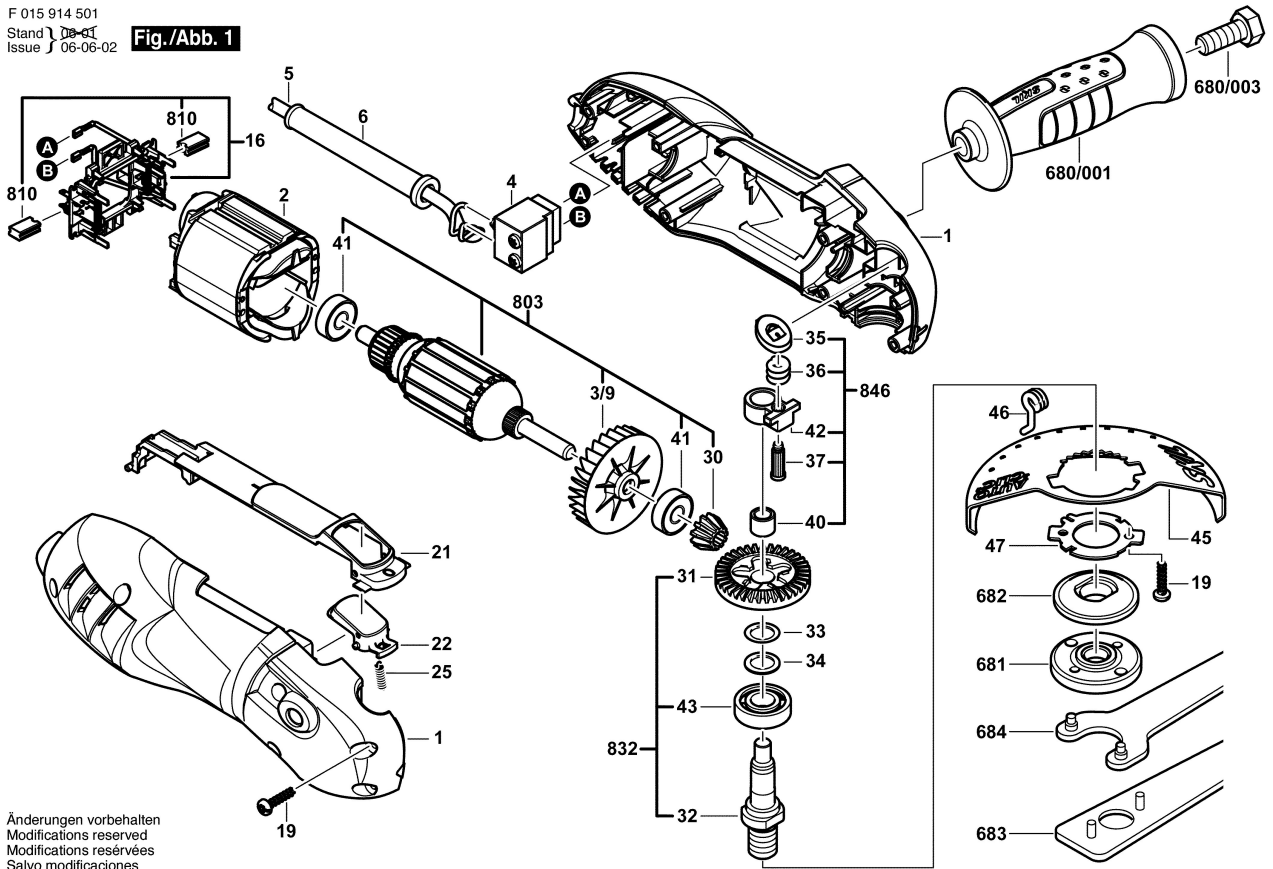

Änderungen vorbehalten
 Modifications reserved
 Modifications réservées
 Salvo modificaciones