

F015 917 5A1  
Issue  
Stand

Fig./Abb. 1

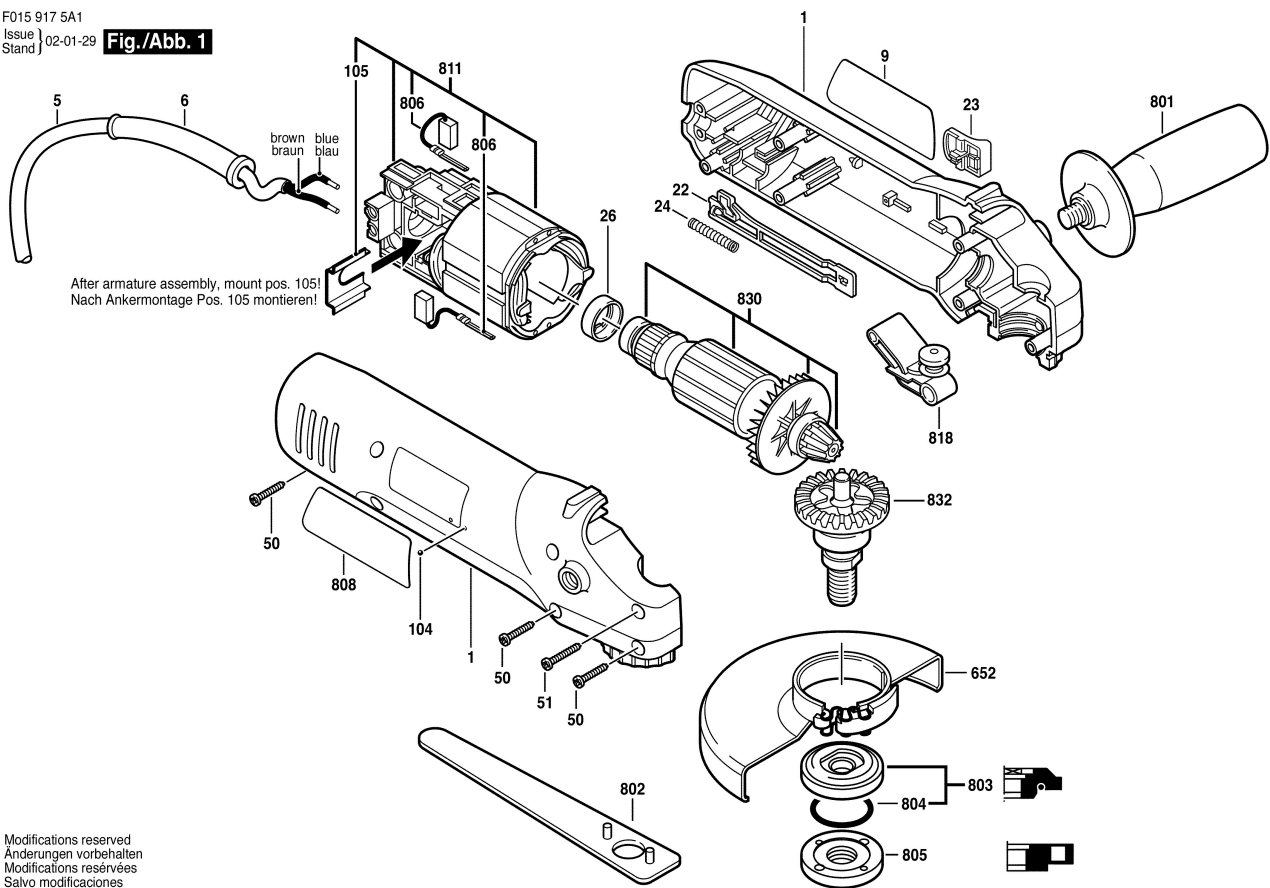

Modifications reserved  
Änderungen vorbehalten  
Modifications réservées  
Salvo modificaciones