

F 015 924 501
Stand 07-05
Issue 08-02-25

Fig./Abb. 1

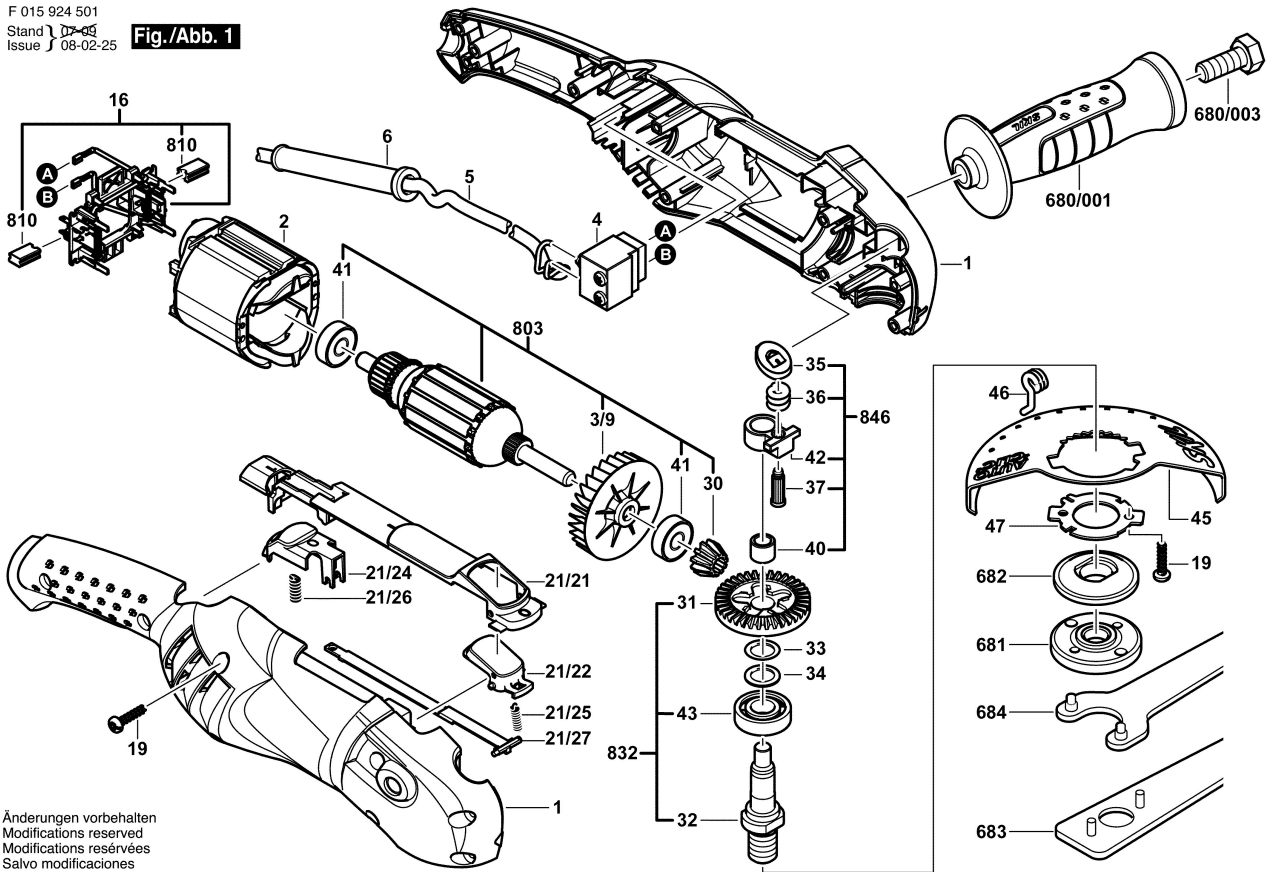

Änderungen vorbehalten
Modifications reserved
Modifications réservées
Salvo modificaciones