

F 015 929 5A1
 Stand } 03-05
 Issue } 03-06-30

Fig./Abb. 1

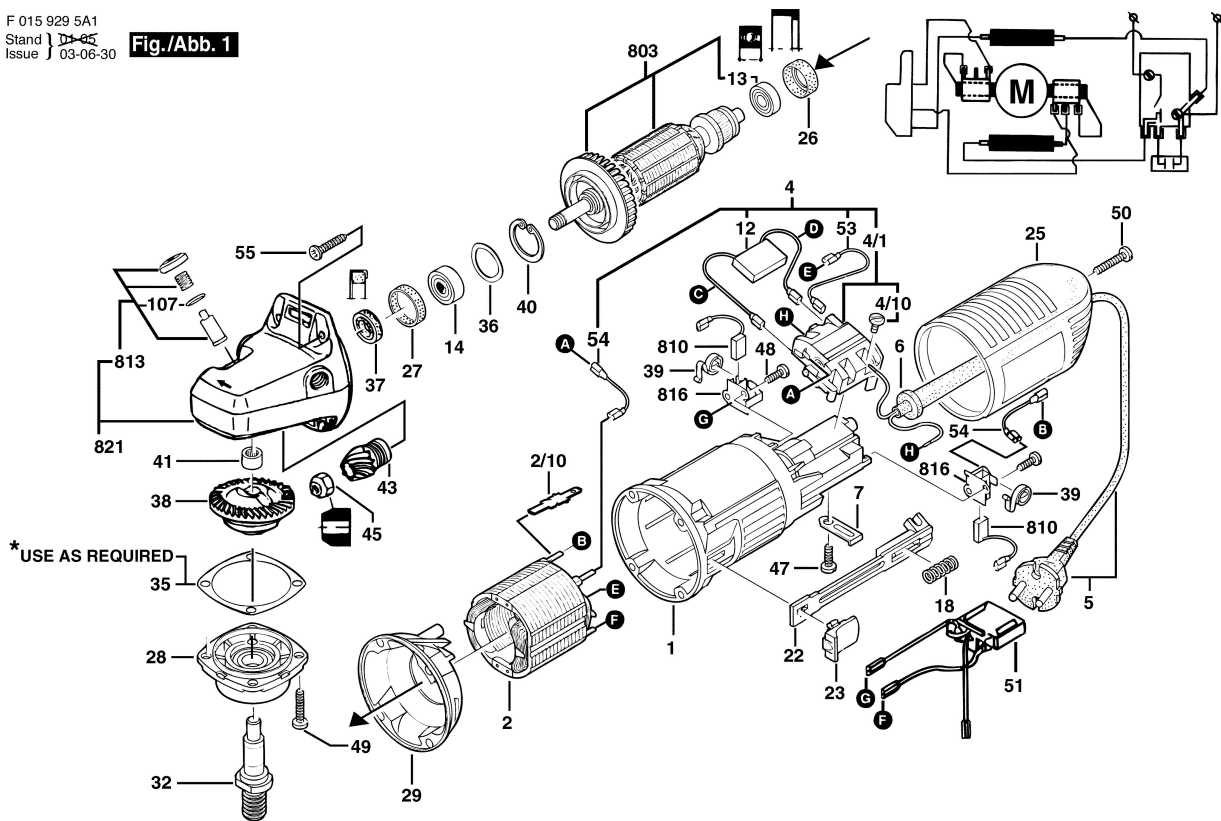

*USE AS REQUIRED

Änderungen vorbehalten
 Modifications reserved
 Modifications reserves
 Salvo modificaciones

F 015 929 5A1
 Stand } 00-05-31
 Issue }

Fig./Abb. 2

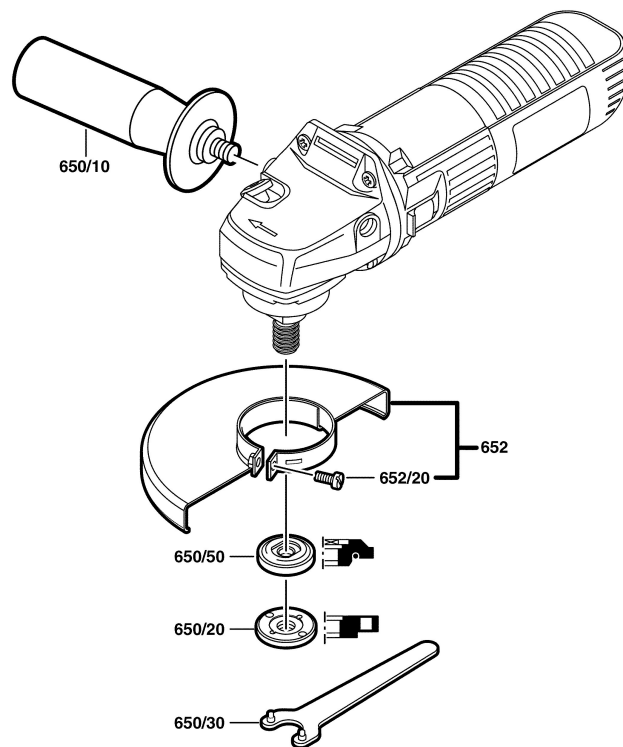

Änderungen vorbehalten
 Modifications reserved
 Modifications reserves
 Salvo modificaciones