

F 015 935 211
Stand | 10-12-22
Issue | 11-01-26

Fig./Abb. 1

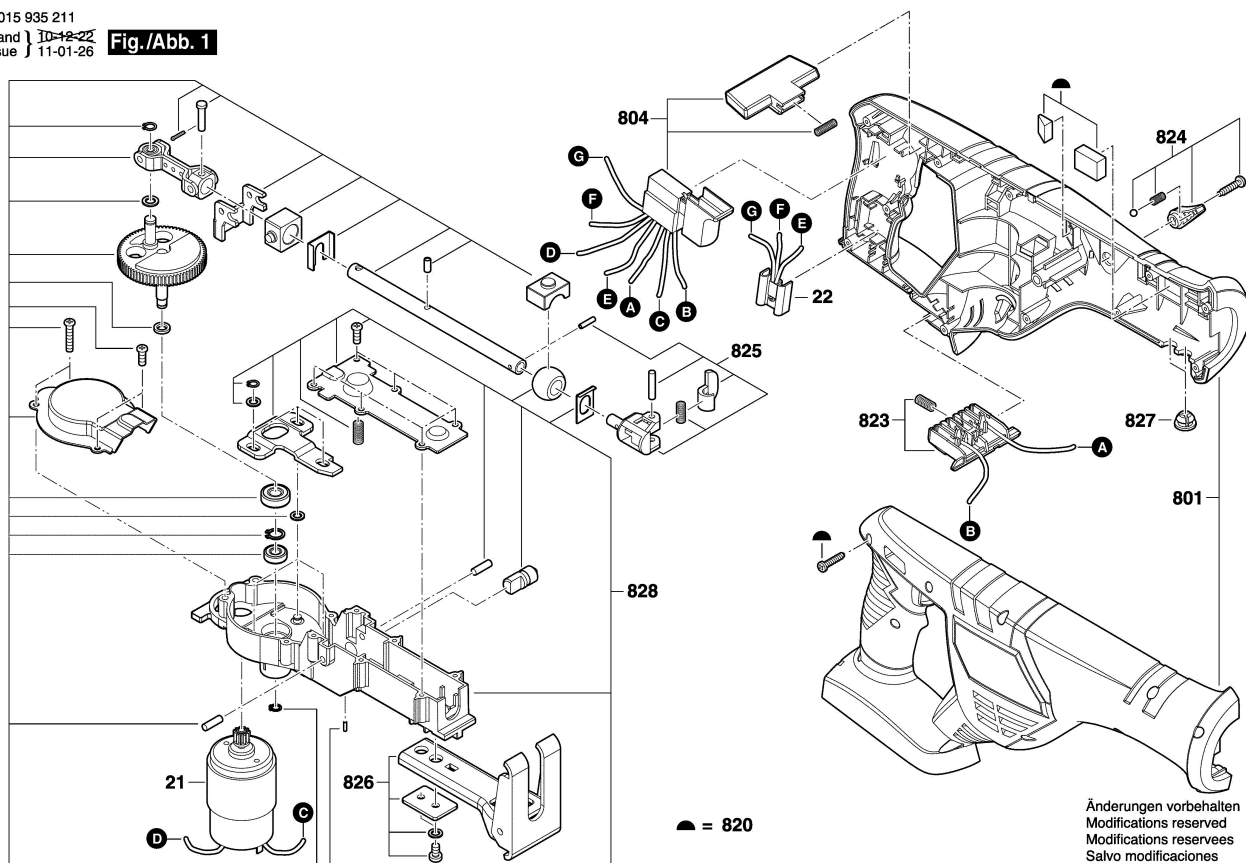

Änderungen vorbehalten
Modifications reserved
Modifications reserves
Salvo modificaciones