

F 015 900 301
Stand 1 04-10
Issue J 06-05-02

Fig./Abb. 1

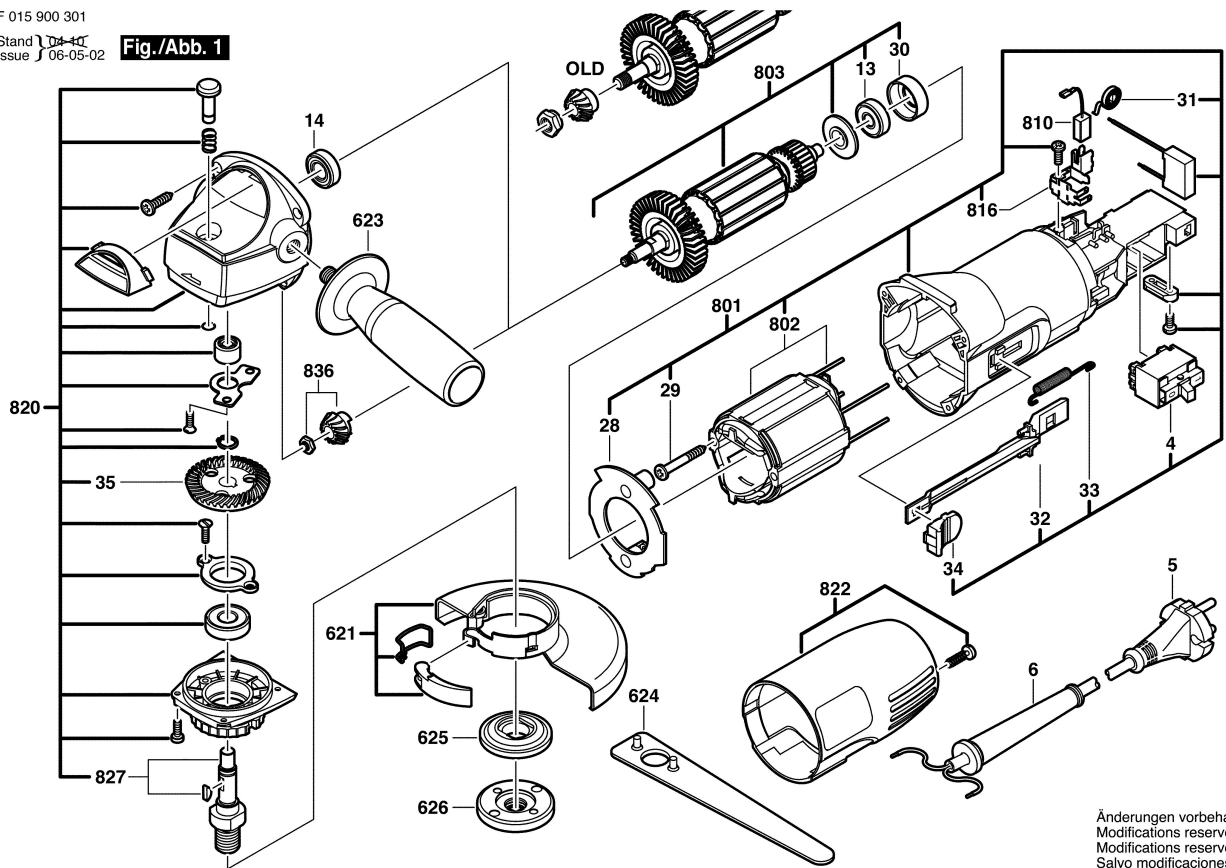

Änderungen vorbehalten
Modifications reserved
Modifications reserves
Salvo modificaciones