

F 015 945 001
Stand 05-12
Issue 06-06-14

Fig./Abb. 1

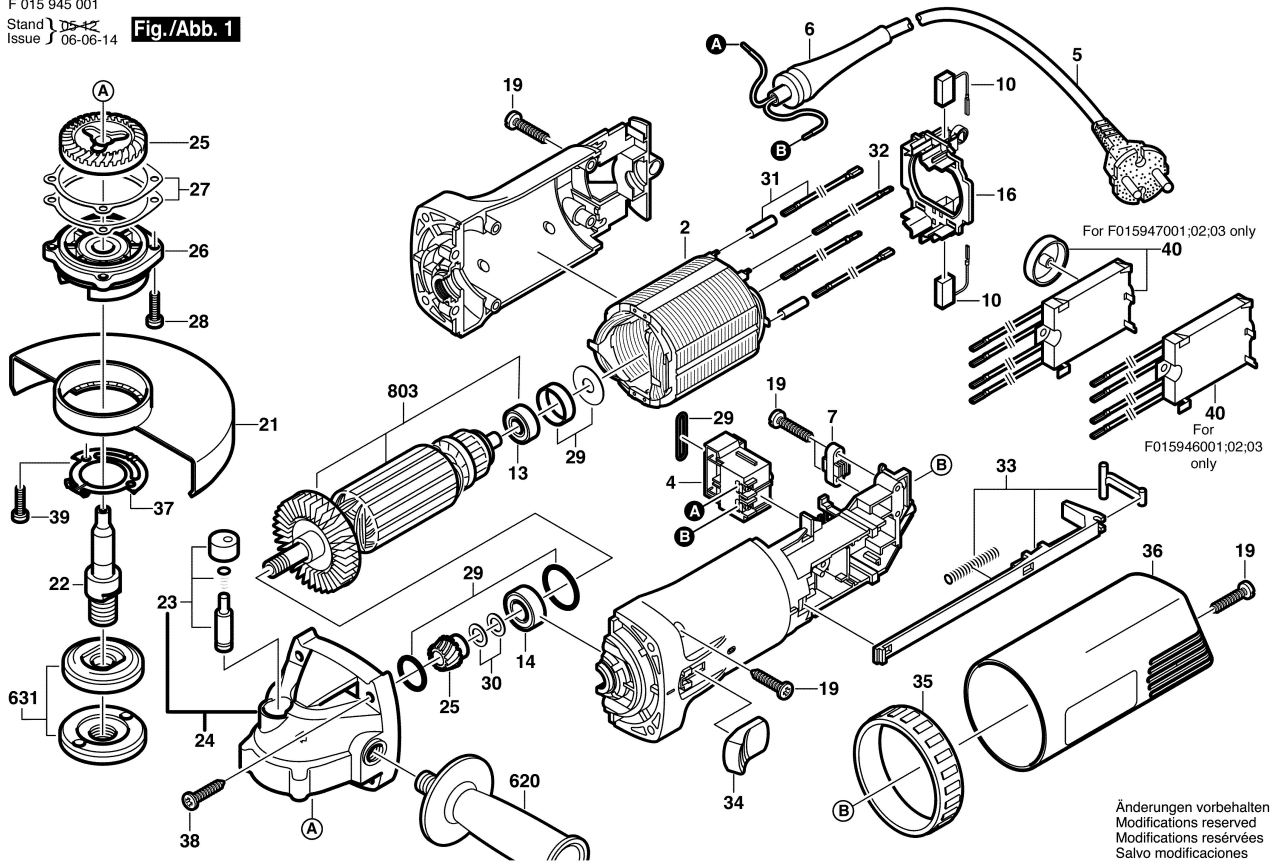

Änderungen vorbehalten
Modifications reserved
Modificaciones reservadas
Salvo modificaciones