

F 015 945 011
Stand Issue J 07-10-08

Fig./Abb. 1

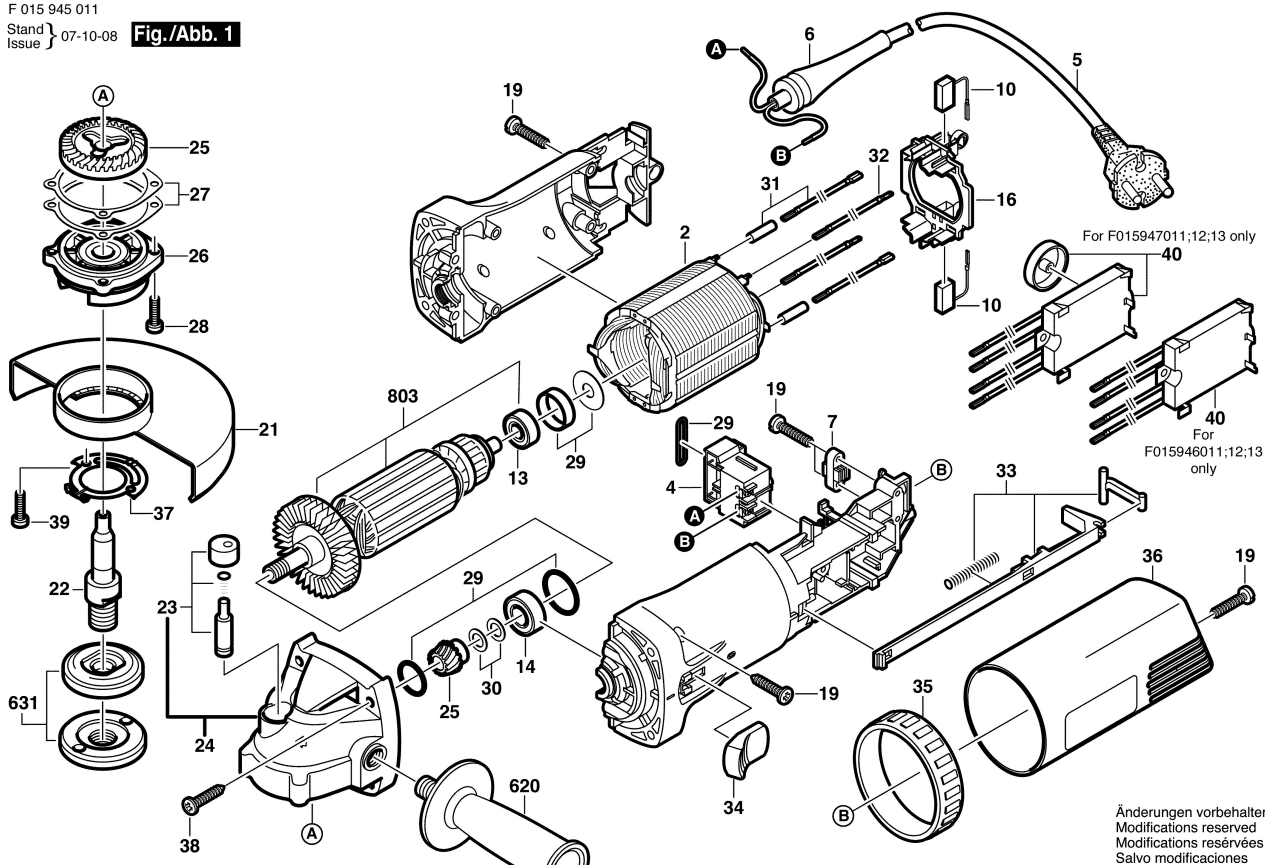

Änderungen vorbehalten
Modifications reserved
Modificaciones reservadas
Salvo modificaciones